

# Application, Installation, & Service Manual

## PC-Series Pool Conditioner

### Pool Room Dehumidifier (R454b)

with Heat Recovery to Air (standard)

with Heat Recovery to Pool Water (option)

with Heat Rejection to Outdoor Unit or Ground Loop (option)

### Model Sizes 45-80



*optional outdoor unit  
for air conditioning*

Maritime Geothermal Ltd.  
P.O. Box 2555, 170 Plantation Road  
Petitcodiac, NB E4Z 6H4  
(506) 756-8135



info@nordicghp.com  
www.nordicghp.com  
002748MAN-00



## SAFETY PRECAUTIONS



- WARNING:** These units use an **A2L** refrigerant, which is mildly flammable. Installation and service work should only be performed by properly trained and certified technicians.
- WARNING:** To avoid electric shock, which can cause serious injury or death, ensure all access panels are in place and properly secured before applying power to the unit. Before performing service or maintenance on the heat pump system, ensure all power sources are **DISCONNECTED**.
- WARNING:** Heat pump systems contain refrigerant under high pressure and as such can be hazardous to work on. Only qualified service personnel should install, repair, or service the heat pump.
- CAUTION:** Safety glasses and work gloves should be worn at all times whenever a heat pump is serviced. A fire extinguisher and proper ventilation should be present whenever brazing is performed.
- CAUTION:** Venting refrigerant to atmosphere is illegal. A proper refrigerant recovery system must be employed whenever repairs require removal of refrigerant from the heat pump.

## Model Nomenclature

**PC—65—X—1S—T—KDE—xx**

**Series:** ←  
PC = Pool Conditioner

**Nominal Size:** ←  
45 = 031 compressor  
55 = 042 compressor  
65 = 054 compressor  
75 = 061 compressor  
80 = 067 compressor

**Refrigerant:** ←  
X = R454b

**Voltage Code:** ←  
1 = 208/230-1-60  
2 = 208-3-60  
4 = 460-3-60  
6 = 220-1-50  
7 = 380-3-50

**Compressor:** ←  
S = single stage scroll

**Revision:**  
01, 02 etc.

**Air Discharge:**  
S = Side  
T = Top (up)  
D = Down

**Air Return:**  
R = Right Side

**Blower Motor:**  
E = ECM (Variable Speed)

**Blower Type:**  
D = Direct Drive

**Air Coil:**  
K = Coated

**Pool Water Coil / Heat Exchanger:**  
T = Titanium  
X = NONE

**AC2—65—X—1/6—KDE—xx**

**Series:** ←  
AC2 = PC Outdoor Condenser

**Nominal Size:** ←  
45 = for PC-45  
55 = for PC-55  
65 = for PC-65  
75 = for PC-75  
80 = for PC-80

**Refrigerant:** ←  
X = R454b

**Revision:**  
01, 02 etc.

**Blower Motor:**  
E = ECM (Variable Speed)

**Blower Type:**  
D = Direct Drive

**Air Coil:**  
S = Standard  
K = Coated

**Voltage Code:**  
1/6 = 208-277VAC, 50/60Hz

APPLICATION/AVAILABILITY TABLE - PC-SERIES INDOOR UNIT										
MODEL	REFRIGERANT	VOLTAGE	STAGES	INDOOR COIL	COILS/BLOWER/ AIR RETURN	AIR DISCHARGE	REVISIONS			
PC-45	X	1 2 4	S	T X	K D E R	T S D	01			
PC-55	X	1 2 4	S	T X	K D E R	T S D	01			
PC-65	X	1 2 4	S	T X	K D E R	T S D	01			
PC-75	X	1 2 4	S	T X	K D E R	T S D	01			
PC-80	X	1 2 4	S	T X	K D E R	T S D	01			

This manual applies only to the models and revisions listed in this table.

APPLICATION/AVAILABILITY TABLE - OPTIONAL AC2-SERIES OUTDOOR UNIT										
MODEL	REFRIGERANT	VOLTAGE	AIR COIL	BLOWER TYPE	BLOWER MOTOR	REVISIONS				
AC2-45	X	1/6	K	D	E	01				
AC2-55	X	1/6	K	D	E	01				
AC2-65/75/80	X	1/6	K	D	E	02				

This manual applies only to the models and revisions listed in this table.

APPLICATION/AVAILABILITY TABLE - OPTIONAL GROUND LOOP HEAT EXCHANGER / WATER COIL			
PC MODEL SIZE	ACCESSORY WATER COIL		CIRCULATOR
PC-45	03-7001	(BTSSC-60)	UP15-58 OR EQUIV.
PC-55 PC-65	03-7019	(BTSSC-72)	UP26-99/NRF-36 OR EQUIV.
PC-75 PC-80	03-7040	(BTSSC-84)	

APPLICATION TABLE - FIRMWARE AND PC APP			
Firmware	Version*	Associated PC APP	Version
MGT GEN2 Bootload Firmware	V3.92+	MGT GEN2 PC APP	V2.20+

Maritime Geothermal Ltd. has a continuous improvement policy and reserves the right to modify specification data at any time without prior notice .

# Table of Contents

<b>Tables &amp; Documents</b>	<b>5</b>	<b>Operation</b>	<b>25</b>
<b>System Description</b>	<b>6</b>	BACnet Control	25
General Overview	6	Air Thermostat Operation, Placement, Setup	25
1. Air Reheat Mode	6	Changing Air Setpoints Using PC App	26
2. Pool Water Heat Mode	6	Pool Water Temperature Control	27
3. Heat Rejection Mode	6	1. Pool water: Setpoint Control	27
Auxiliary Air Heat	6	Setpoint Control Method 1 - Indoor Loop	27
Operating Mode Tables	7	Setpoint Control Method 2 - External HTS/CTS	27
<b>PC Sizing</b>	<b>8</b>	2. Pool Water: Signals Control	27
Pool Surface Area	8	<b>PC Application (PC App)</b>	<b>28</b>
PC Unit Sizing	8	<b>LCD Interface &amp; Menus</b>	<b>40</b>
Plenum Heater Sizing	9	<b>BACnet Interface</b>	<b>42</b>
<b>Installation Basics</b>	<b>10</b>	<b>Startup Procedure</b>	<b>47</b>
Sample Bill of Materials	10	Pre-start Inspection	47
Unpacking the unit	10	Unit Startup	47
PC Indoor Unit Placement	10	Startup Record	49
Optional AC2 Outdoor Unit Placement	11	<b>Routine Maintenance</b>	<b>50</b>
Outdoor Fan Speed Reduction	11	<b>Troubleshooting Guide</b>	<b>51</b>
Optional Ground Loop Heat Exchanger	11	<b>Repair Procedures</b>	<b>65</b>
Air Thermostat Placement	11	Pumpdown Procedure	65
Plenum Heater Installation	11	General Repair Procedure	65
<b>Wiring</b>	<b>12</b>	Vacuuming & Charging Procedure	65
PC-Series Power Supply Connections	12	Compressor Replacement Procedure	66
Control Transformer	12	Outdoor Fan Replacement Procedure	66
Auxiliary Plenum Heater: Power Supply Connections	12	Control Board Replacement Procedure	67
Auxiliary Plenum Heater: Signal Connections	12	LCD Interface (Display) Board Replacement Procedure	68
Pool Pump Signal Connections (PC-T only)	12	Air Thermostat Sensor Replacement Procedure	68
Pool Water Flow Switch Connections (PC-T only)	12	<b>Model Specific Information</b>	<b>69</b>
Optional AC2 Outdoor Unit: Power Supply Connections	13	Shipping Information	69
Optional AC2 Outdoor Unit: Signal Connections	13	Refrigerant Charge	69
Alternative Heat Rejection Methods: Connections	13	Control Temperature Limits	69
Air Thermostat Connections	13	AC2-Series Outdoor Unit Sound Levels (dBA)	69
Pool Auxiliary Heat Connections (PC-T only)	13	Capacity Ratings	70
Disable Switch (field installed)	13	Cooling Mode Performance Tables	71
Accessory Connections	13	Required Water Flow Rates	74
002298CDG - Typical PC-Series Wiring Connections	14	Pool Water Pressure Drop	74
<b>Piping</b>	<b>15</b>	Pressure Drop for Optional Ground Loop Coil	74
Pool Water Lines	15	<b>Electrical Specifications</b>	<b>75</b>
Condensate Drain	15	Indoor Airflow	76
Simultaneous Pool/Hot Tub Heating	15	Wiring & Electrical Box Diagrams (208/230-1-60)	77
Air Conditioning with Ground Loop Coil	15	Wiring & Electrical Box Diagrams (208-3-60)	79
Air Conditioning with Open Loop Water	15	Wiring & Electrical Box Diagrams (460-3-60)	81
002297PDG - Typical Loop Connections - PC Series	16	AC2 (Outdoor Condenser) Wiring Diagrams	83
001824PDG - PC-Series Connections to Pool & Hot Tub	17	PC-T Refrigeration Circuit - Pool Water Heat Mode	84
002641CDG - Piping for Ground Loop Heat Rejection	18	PC-T Refrigeration Circuit - Air Reheat Mode	85
001045CDG - PC-Series Open Loop Heat Rejection	19	PC-T Refrigeration Circuit - Heat Rejection Mode	86
<b>Ductwork</b>	<b>20</b>	PC-X Refrigeration Circuit - Air Reheat Mode	87
Duct Systems - General	20	PC-X Refrigeration Circuit - Heat Rejection Mode	88
Supply Duct System	20	<b>Dimensions</b>	<b>89</b>
Return Duct System	20	<b>Appendix A: Control Board Description</b>	<b>90</b>
Plenum Heater	20	<b>Appendix B: USB Driver Installation</b>	<b>94</b>
Duct Sizing Guide	22	<b>Appendix C: PC App Installation (Win11)</b>	<b>95</b>
<b>Heat Rejection Line Set</b>	<b>23</b>	<b>Appendix D: PC App Installation (Win10)</b>	<b>96</b>
AC2 Outdoor Unit / Ground Loop Coil	23	<b>Appendix E: Updating Firmware</b>	<b>97</b>
Line Set Interconnect Tubing	23	<b>Warranty</b>	<b>100</b>
Indoor Unit Connections	23		
Outdoor Unit Connections	23		
Oil Traps, Filter-Dryer, Pipe Insulation	23		
Silver Soldering Line Sets	23		
Pressure Testing	24		
Vacuuming the System	24		
Charging the System	24		

# Tables & Documents

## Tables

<a href="#">Table 1 - Pool Conditioner Operating Modes (with optional AC2 outdoor condenser)</a>	7
<a href="#">Table 2 - Pool Conditioner Operating Modes (without optional AC2 outdoor condenser)</a>	7
<a href="#">Table 3 - Step by Step Pool Evaporation Rate Calculation</a>	8
<a href="#">Table 4 - PC Typical Sizing (60 Hz)</a>	8
<a href="#">Table 5 - PC Typical Sizing (50 Hz)</a>	8
<a href="#">Table 6 - Activity Factor</a>	8
<a href="#">Table 7 - Evaporation Rate Chart (50% RH)</a>	9
<a href="#">Table 8 - Evaporation Rate Chart (60% RH)</a>	9
<a href="#">Table 9 - Plenum Heater Sizing</a>	9
<a href="#">Table 10 - PC-Series Power Supply Connections</a>	12
<a href="#">Table 11 - Control Transformer</a>	13
<a href="#">Table 12 - Plenum Heater Signal Connections</a>	12
<a href="#">Table 13 - Pool Pump Signal Connections</a>	12
<a href="#">Table 14 - AC2-Series Power Supply Connections</a>	13
<a href="#">Table 15 - AC2-Series Signal Connections</a>	13
<a href="#">Table 16 - Air Thermostat Connections</a>	13
<a href="#">Table 16a - Pool Auxiliary Heat Connections</a>	13
<a href="#">Table 17 - Duct Sizing Guide</a>	22
<a href="#">Table 18 - Line Set Sizing, 3-way Service Valve Tooling &amp; Torques</a>	23
<a href="#">Table 19 - Extra Charge Required</a>	24
<a href="#">Table 20 - Extra Charge Chart</a>	24
<a href="#">Table 21 - BAPI STAT4 Settings</a>	25
<a href="#">Table 22 - BACnet Objects - Control Signals (Read/Write)</a>	42
<a href="#">Table 23 - BACnet Objects - Data (Read Only)</a>	43
<a href="#">Table 24 - BACnet Objects - Operation Mode Description (Read Only)</a>	44
<a href="#">Table 25 - BACnet Objects - Limits Description (Read Only)</a>	44
<a href="#">Table 26 - BACnet Objects - Alarm Descriptions (Read Only)</a>	45
<a href="#">Table 27 - BACnet Objects - Fault Descriptions (Read Only)</a>	46
<a href="#">Table 28 - Shipping Information (PC)</a>	69
<a href="#">Table 29 - Shipping Information (AC2 Outdoor Unit)</a>	69
<a href="#">Table 30 - Refrigerant Charge</a>	69
<a href="#">Table 31 - Control Temperature Limits</a>	69
<a href="#">Table 32 - AC2-Series Outdoor Unit Sound Levels (dBA)</a>	69
<a href="#">Table 33 - PC-Series Capacity Ratings (60 Hz)</a>	70
<a href="#">Table 34 - PC-Series Capacity Ratings (50 Hz)</a>	70
<a href="#">Table 35 - Required Water Flow Rates</a>	74
<a href="#">Table 36 - Pool Water Pressure Drop (all model sizes)</a>	74
<a href="#">Table 37 - Pressure Drop for Optional Ground Loop Heat Rejection Coil</a>	74
<a href="#">Table 38 - PC-Series Electrical Data</a>	75
<a href="#">Table 39 - Plenum Heater Electrical Data</a>	75
<a href="#">Table 40 - Indoor Airflow</a>	76
<a href="#">Table 41 - Indoor Airflow for Auxiliary Heat</a>	76
<a href="#">Table 42 - Indoor Airflow for Air Recirculation</a>	76
<a href="#">Table A1 - Control Board Connector Descriptions (Top)</a>	93
<a href="#">Table A2 - Control Board Connector Descriptions (Left Side)</a>	93
<a href="#">Table A3 - Control Board Connector Descriptions (Bottom)</a>	94
<a href="#">Table A4 - Control Board Connector Descriptions (Right Side)</a>	95

## Documents

<a href="#">002298CDG - Typical PC-Series Wiring Connections</a>	14
<a href="#">002297PDG - Typical Loop Connections - PC Series</a>	16
<a href="#">001824PDG - PC-Series Connections to Pool &amp; Hot Tub</a>	17
<a href="#">002641CDG - PC-Series Connections for Ground Loop Heat Rejection</a>	18
<a href="#">001045CDG - PC-Series Connections for Open Loop Heat Rejection</a>	19
<a href="#">001423SCH - PC-Series (GEN2) Schematic Diagram 208/230-1-60</a>	77
<a href="#">001424ELB - PC-Series Electrical Box Diagram 208/230-1-60</a>	78
<a href="#">001825SCH - PC-Series (GEN2) Schematic Diagram 208-3-60</a>	79
<a href="#">001826ELB - PC-Series Electrical Box Diagram 208-3-60</a>	80
<a href="#">002292SCH - PC-Series (GEN2) Schematic Diagram 460-3-60</a>	81
<a href="#">002293ELB - PC-Series Electrical Box Diagram 460-3-60</a>	82
<a href="#">002261SCH - PC Outdoor Condenser (AC2-Series) 1-Fan Schematic Diagram</a>	83
<a href="#">002262SCH - PC Outdoor Condenser (AC2-Series) 4-Fan Schematic Diagram</a>	83
<a href="#">000352RCD - PC-T Refrigeration Circuit - Pool Water Heat Mode</a>	84
<a href="#">000353RCD - PC-T Refrigeration Circuit - Air Reheat Mode</a>	85
<a href="#">000354RCD - PC-T Refrigeration Circuit - Heat Rejection Mode</a>	86
<a href="#">002698RCD - PC-X Refrigeration Circuit - Air Reheat Mode</a>	87
<a href="#">002699RCD - PC-X Refrigeration Circuit - Heat Rejection Mode</a>	88

# System Description

## General Overview

The PC-Series pool conditioner is a pool room dehumidifier, that cools and dehumidifies pool room air whenever it is running. This is an energy-efficient alternative to the traditional method of controlling pool room humidity, which involves exhausting moist air and introducing fresh outside air that must then be heated or cooled to the room temperature.

The refrigeration cycle used to cool the air (similar to that that used in air conditioners or refrigerators) produces excess heat, equal to the amount of electrical energy put in to run the compressor. This compressor heat (plus the heat removed from the air to cool it) can be put into one of three places: into the pool water, back into the pool room air, or rejected to either:

- a) outdoor air via an optional **AC2-series** outdoor condenser, *or*
- b) an existing geothermal ground loop.

There are therefore three operating modes (listed below). The operating mode is determined according to the inputs from the supplied communicating room air thermostat that measures the room temperature and humidity, and a temp sensor with internal routine that monitors pool water temperature. The air thermostat has a user interface that allows changing the air temperature and humidity setpoints.

Air coils are e-coated for corrosion protection, and pool water heat exchanger is titanium/PVC for a corrosion resistance that is much superior to steel, copper, or CuNi. The cabinet is powder coated galvanized sheet metal, which achieves complete coverage and has a corrosion protection that is superior to stainless steel due to the potential for impurities in stainless material. Control is overseen by the Nordic GEN2 programmable control board, which has many advanced features like laptop connectivity via the free PC App software, data logging & graphing, BACnet connectivity, and electronic temperature & pressure sensors. An electrically commutated (ECM) blower motor with adjustable airflow is standard.

## 1. Pool Water Heat Mode

In this default mode, air is cooled and dehumidified by the PC's internal refrigerant-to-air evaporator coil. **Heat is rejected to pool water**, some portion of which is circulated through the PC's internal refrigerant-to-water condenser coil by the pool filter pump. The air emerges drier and cooler than it went in, and water emerges warmer than it went in.

The priority mode is always pool water heating, to avoid unnecessary compressor cycling and mode switching. Therefore if there is demand for both air and pool water heating, the pool water heating demand will be satisfied first.

**Typically, while performing dehumidification the PC-Series unit will provide all of the pool water heating required for an indoor pool, with no auxiliary pool water heating required.** However, an option is available for *no pool heat coil* for applications that don't require it (see pages 2/3).

## 2. Air Reheat Mode

In this mode, air is cooled and dehumidified by the PC's internal refrigerant-to-air evaporator coil. **Air is then reheated** with the PC's internal refrigerant-to-air condenser coil. There is a net heating effect on the air, equal to compressor power input. The air emerges drier and warmer than it went in.

Auxiliary heat will be required for the pool room air during colder weather (see below).

## 3. Heat Rejection Mode

### a) AC2-Series Outdoor Unit

In this mode, air is cooled and dehumidified by the PC's internal refrigerant-to-air evaporator coil. **Heat is rejected to an optional outdoor condenser unit (AC2-Series)**, which is available as an accessory from Maritime Geothermal Ltd., and may only be necessary in warmer climates or in buildings with a high solar gain. There is automatic detection of the outdoor condenser by the PC unit. If not present, either air reheat mode or pool water heat mode will be engaged instead, according to a user setting accessible through the PC App software.

There are two sizes of outdoor unit, one for PC sizes 45/55 and one for PC sizes 65/75/80. The AC2 contains only the outdoor refrigerant-to-air heat exchanger (air coil), and an ECM hub motor axial fan. The hub motor fan is speed controlled by the PC's GEN2 control board based on refrigerant head pressure. This results in maximum airflow when needed, while allowing reduced airflow at other times for noise and power savings.

Because the outdoor unit is only used for heat rejection, there is no outdoor expansion valve (EEV) or defrost cycle logic necessary. Although the NORDIC AC2 and ACE outdoor units look similar, the AC2 is used with the Nordic PC series, and the ACE (which includes the outdoor EEV and defrost logic) is used with Nordic air source heat pumps like the ATW, ATA, and ATF series.

### b) Geothermal Ground Loop

If there is an existing closed geothermal loop at the site, it is desirable to instead reject heat into this loop so heat can be stored and be of benefit during cold weather heating.

To do this, a refrigerant to water heat exchanger (and a water/antifreeze circulation pump) can be connected in place of the outdoor unit. Suitable heat exchangers are available from Maritime Geothermal Ltd..

As a third option, open loop (well water or other cold water loop) may also be incorporated in the pool water piping for heat rejection; see [Piping](#) chapter.

## Auxiliary Air Heat

While PC is operating in any mode, auxiliary heat (usually an electric plenum heater) will also be engaged if the air temperature drops below the air heat Auxiliary/Stage 2 setpoint. It will provide additional air heating on cold days when the pool water requires all or most of the unit's heat output.

An electric plenum heater is included as per [Sizing](#) chapter. This heater is installed in the air discharge ductwork outside the PC unit, and is controlled via dry contacts **CP-1-2** by the PC's control board.

Other types of air heat (gas, hydronics from a water-to-water geothermal system) can be used, and should be controlled by the above mentioned dry contacts.

## Auxiliary Pool Water Heat

Even when pool water heat coil is present, there maybe certain commercial applications where auxiliary pool heat is required.

The control board can control this external pool water heating device via its hydronic Auxiliary/Stage 2 setpoint and dry contacts **D1-D2**.

**TABLE 1 - Pool Conditioner Operating Modes (with optional AC2 outdoor condenser)**

AIR DEMAND (from air thermostat)			POOL WATER HEAT DEMAND (if present, from set-point control routine)	PC OPERATING MODE
DEHUMIDIFY	COOL	HEAT		
				OFF
			X	POOL WATER HEAT MODE
		X		AIR REHEAT MODE
		X	X	POOL WATER HEAT MODE
X				HEAT REJECTION MODE
X			X	POOL WATER HEAT MODE
X		X		AIR REHEAT MODE
X		X	X	POOL WATER HEAT MODE
	X			HEAT REJECTION MODE
	X		X	POOL WATER HEAT MODE
X	X			HEAT REJECTION MODE
X	X		X	POOL WATER HEAT MODE

**TABLE 2 - Pool Conditioner Operating Modes (without optional AC2 outdoor condenser)**

AIR DEMAND (from air thermostat)		POOL WATER HEAT DEMAND (if present, from set-point control routine)	PC OPERATING MODE
DEHUMIDIFY	HEAT		
			OFF
		X	POOL WATER HEAT MODE
	X		AIR REHEAT MODE
	X	X	POOL WATER HEAT MODE
X			SELECTABLE: AIR REHEAT OR POOL WATER HEAT MODE
X		X	POOL WATER HEAT MODE
X	X		AIR REHEAT MODE
X	X	X	POOL WATER HEAT MODE

# PC Sizing

## Pool Surface Area

As the square footage of the pool increases, the evaporation rate will increase proportionally. This is due to the increase in size of the surface water / air contact area. The depth, shape, and total volume of the pool do not affect the evaporation rate.

## PC Unit Sizing

The amount of evaporation occurring in a residential pool application of a given size is governed mainly by the temperatures at which the air and water are maintained. It is common practice to keep the air temperature 2°F above the pool water temperature. The lower the air temperature is in comparison to the water temperature, the higher the evaporation rate will be. The evaporation rate of the pool increases when the following occur:

- 1) Pool water temperature increases
  - 2) Activity level / wet floor area increases
  - 3) Airflow across pool surface increases
  - 4) Room air temperature decreases
  - 5) Room relative humidity level decreases
- 1) **Pool water temperature:** The temperature of the pool water in relation to the air temperature is one of the most important factors in determining overall evaporation rate from the pool. As the room air temperature decreases in relation to the pool water, the evaporation rate will increase dramatically. The normal pool water temperature range for private pool use is from 78°F to 82°F. The air temperature should be kept 1° to 2°F above the water temperature for the most economical operation of the pool conditioner.
- 2) **Activity level / wet floor area:** During pool use, water will be drawn out of the pool by the action of swimmers leaving and re-entering the pool during normal activities. This water will accumulate on the floor surrounding the pool and will contribute to the overall surface exposed to the air for evaporation purposes. If the pool floor is heated then the evaporation rate will exceed that of the pool itself and this extra wetted area should be considered in sizing the pool conditioner.

Model	Airflow	Pool Surface Area	Moisture Removal @50%RH	Moisture Removal @60%RH
	cfm (L/s)	ft <sup>2</sup> (m <sup>2</sup> )	lb(kg)/hr	lb(kg)/hr
PC-45	1150 (540)	600 (56)	14 (6.4)	18 (8.2)
PC-55	1500 (710)	800 (74)	19 (8.6)	23 (10)
PC-65	1900 (900)	1050 (98)	24 (11)	30 (14)
PC-75	2200 (1040)	1200 (110)	28 (13)	33 (15)
PC-80	2300 (1085)	1350 (130)	32 (14)	38 (17)

\*Residential application with Tp=80°F and Ta=82°F  
EWT=80°F and EAT=82°F

AF	Application
0.5	residential
0.65	therapy, aquafit, elderly swim, fitness club, condominium
0.8	hotel
0.8	school
1.0	public pool, spa, or whirlpool

Step	Action	Variable	Example	Unit
1	Select pool water temperature*	Tp	80	°F
2	Select pool room air temperature*	Ta	82	°F
3	Select Non-Active Humidity Level (50 or 60%)	RHna	50	%
4	Select the number of active hours	Ha	2	hours
5	Calculate the number of non-active hours = 24 - Ha	Hna	22	hours
6	Lookup the active Evaporation Rate Factor from <b>TABLE 8</b>	ERFa	0.036	lb/hr/ft <sup>2</sup>
7	Lookup the non-active Evaporation Rate Factor from <b>TABLE 7</b> or <b>8</b> (50 or 60% from Step 3).	ERFna	0.048	lb/hr/ft <sup>2</sup>
8	Select the activity factor (see <b>TABLE 6</b> )	AF	0.5	
9	Calculate the Average Evaporation Rate Factor = [(Ha x ERFa x AF) + (Hna x ERFna x 0.5)] / 24	ERFavg	0.0235	lb/hr/ft <sup>2</sup>
10	Select Pool Surface Area	Ap	800	ft <sup>2</sup>
11	Calculate Pool Evaporation Rate = Ap * ERFavg --> match to Moisture Removal in <b>TABLE 4</b>	ERp	18.8	lb/hr

\*It is recommended that the air temperature be 2°F above the pool water temperature. The lower the air temperature in comparison to the water temperature, the higher the evaporation rate. Typical residential values are Tp = 80°F (27°C) and Ta = 82°F (28°C).



TABLE 7 - Evaporation Rate Chart (50% RH) – lb/hr/ft <sup>2</sup>												
Air Temperature (Ta) °F												
		86	85	84	83	82	81	80	79	78	77	76
Pool Water Temp. (Tp) °F	78	0.034	0.036	0.038	0.038	0.040	0.042	0.044	0.046	0.048	0.050	0.052
	80	0.042	0.044	0.046	0.046	0.048*	0.050	0.050	0.052	0.054	0.056	0.058
	82	0.048	0.050	0.052	0.052	0.054	0.056	0.058	0.060	0.062	0.064	0.066
	84	0.056	0.058	0.060	0.060	0.062	0.064	0.066	0.068	0.070	0.070	0.072
	86	0.062	0.066	0.068	0.068	0.070	0.072	0.074	0.076	0.076	0.078	0.080
	88	0.072	0.074	0.076	0.076	0.078	0.080	0.082	0.084	0.086	0.086	0.088
	90	0.080	0.082	0.084	0.084	0.086	0.088	0.090	0.092	0.094	0.096	0.098
	92	0.090	0.092	0.094	0.094	0.096	0.098	0.100	0.100	0.102	0.104	0.106
	94	0.098	0.102	0.104	0.104	0.106	0.108	0.108	0.110	0.112	0.114	0.116
	96	0.110	0.112	0.114	0.114	0.116	0.118	0.120	0.120	0.122	0.124	0.126
	98	0.120	0.122	0.124	0.124	0.126	0.128	0.130	0.132	0.134	0.136	0.138
	100	0.132	0.134	0.136	0.136	0.138	0.140	0.142	0.144	0.146	0.148	0.148
	102	0.144	0.146	0.148	0.148	0.150	0.152	0.154	0.156	0.158	0.158	0.160
104	0.156	0.158	0.160	0.160	0.162	0.164	0.166	0.168	0.170	0.172	0.174	

\* value for recommended setpoints

TABLE 8 - Evaporation Rate Chart (60% RH) – lb/hr/ft <sup>2</sup>												
Air Temperature (Ta) °F												
		86	85	84	83	82	81	80	79	78	77	76
Pool Water Temp. (Tp) °F	78	0.020	0.022	0.026	0.028	0.030	0.032	0.034	0.036	0.038	0.040	0.042
	80	0.026	0.030	0.032	0.034	0.036*	0.038	0.040	0.044	0.046	0.048	0.050
	82	0.034	0.036	0.038	0.042	0.044	0.046	0.048	0.050	0.052	0.054	0.056
	84	0.040	0.044	0.046	0.048	0.050	0.054	0.056	0.058	0.060	0.062	0.064
	86	0.048	0.052	0.054	0.056	0.060	0.060	0.064	0.066	0.068	0.070	0.072
	88	0.058	0.060	0.062	0.064	0.066	0.070	0.072	0.074	0.076	0.078	0.080
	90	0.066	0.068	0.070	0.074	0.076	0.078	0.080	0.082	0.084	0.086	0.088
	92	0.074	0.078	0.080	0.082	0.084	0.088	0.090	0.092	0.094	0.096	0.098
	94	0.084	0.088	0.090	0.092	0.094	0.096	0.098	0.100	0.104	0.106	0.108
	96	0.094	0.098	0.100	0.102	0.104	0.106	0.110	0.112	0.114	0.116	0.118
	98	0.106	0.108	0.112	0.114	0.116	0.118	0.120	0.122	0.124	0.126	0.128
	100	0.118	0.120	0.122	0.124	0.128	0.130	0.132	0.134	0.136	0.138	0.140
	102	0.130	0.132	0.134	0.136	0.140	0.142	0.144	0.146	0.148	0.150	0.152
104	0.142	0.144	0.146	0.150	0.152	0.154	0.156	0.158	0.160	0.162	0.164	

\* value for recommended setpoints

- Airflow across pool surface:** Increased airflow across the surface area of the pool increases the evaporation rate. Ducting should be designed to minimize the airflow across the pool to reduce this effect. See the **Ductwork** section for more information.
- Room air temperature:** As mentioned in (1), the pool room temperature is normally kept slightly above the water temperature to minimize the amount of evaporation taking place.
- Room relative humidity:** The relative humidity setpoint for most pool areas is from 50% to 60%. Lowering the relative humidity setpoint will increase the evaporation rate from the pool thus causing the pool conditioner to run more, but may be necessary to prevent condensation on some glass surfaces during cold weather. Relative humidity should be set only low enough to prevent condensation from occurring on windows and doors.

**TABLE 3** gives a step by step explanation of how to determine the evaporation rate of the pool. Once the Pool Evaporation Rate (ERp) has been calculated then it can be matched to

the moisture removal for a particular PC model size in **TABLE 4** or **5** (looking in the 50% or 60% columns according to selected RHna).

**TABLE 4** or **5** also gives a general idea as to the size of pool that can be accommodated by each model size for a typical residential installation. This is just a guideline; the Pool Evaporation Rate (ERp) should be calculated as per **TABLE 3**.

### Plenum Heater Sizing

A plenum heater is included according to the below table. They are also available in other sizes on request (5, 7, 10, 15 and 20kW), if another size better matches a heat load calculation for the pool room.

TABLE 9 - Plenum Heater Sizing	
MODEL	kW
PC-45, 55	15
PC-65, 75, 80	20

# Installation Basics

## Sample Bill of Materials

Although not exhaustive, following is a list of materials needed for a typical installation:

### FROM MARITIME GEOTHERMAL

- PC-SERIES POOL CONDITIONER
- COMMUNICATING ROOM THERMOSTAT (SUPPLIED)
- TWISTED-PAIR THERMOSTAT WIRE (SUPPLIED)
- OUTDOOR UNIT SHIELDED SIGNAL WIRE (18-8)
- ELECTRIC PLENUM HEATER (FOR AIR AUX. HEAT)

### OPTIONAL FROM MARITIME GEOTHERMAL

- AC2-SERIES OUTDOOR CONDENSER
- POOL WATER FLOW SWITCH
- GROUND LOOP HEAT EXCHANGER (WATER COIL) FOR HEAT REJECTION (SEE PAGE 3)
- ANTI-VIBRATION PAD FOR UNDER UNIT
- COMPRESSOR SOUND JACKET
- COMPRESSOR SECURE START

### DUCTWORK

- OUTLET PLENUM ADAPTER W/ FLEXIBLE COLLAR
- RETURN AIR ADAPTER W/ FLEXIBLE COLLAR
- FIBREGLASS INSULATION (FOR NOISE, IF REQ'D)
- TRUNK DUCT W/ JOINERS (IF NOT EXISTING)
- 6" ROUND DUCT W/ADAPTERS (IF NOT EXISTING)
- ALUMINUM TAPE
- SHEET METAL SCREWS

### PIPING (IF UNIT EQUIPPED WITH POOL HEAT COIL)

- POOL PUMP & FILTER
- 2" PVC PIPE & FITTINGS & GLUE
- 2" PVC BALL VALVES (2)
- CONDENSATE TRAP ASSEMBLY & DRAIN PIPING
- CONDENSATE PUMP (IF REQ'D)
- CIRCULATOR FOR GROUND LOOP HEAT EXCHANGER FOR HEAT REJECTION (SEE PAGE 3)

### REFRIGERATION (FOR OPTIONAL AC2 OUTDOOR UNIT)

- 1/2" ACR TUBING
- PIPE ISULATION
- EXTRA R454B REFRIGERANT FOR LINESETS >20 FT

### ELECTRICAL

- ELEC. SERVICE WIRE OF CORRECT SIZE
- BREAKER FOR PC UNIT
- PLENUM HEATER SERVICE WIRE
- PLENUM HEATER BREAKER
- WIRE 14-2 (OUTDOOR) FOR OPTIONAL AC2 UNIT
- OUTDOOR DISCONNECT SWITCH FOR AC2 UNIT
- THERMOSTAT WIRE 18-2 (FOR D1-D2 OR CP1-CP2)
- THERMOSTAT WIRE 18-3 (FOR CP-1-2)
- FORK TERMINALS FOR TSTAT WIRE (6)
- TRANSFORMER, CONTACTOR, EXT. ELEC. BOX IF POOL PUMP TO BE CONTROLLED BY PC UNIT
- 2" STYROFOAM INSUL. (IF PAD NOT PURCHASED)

## Unpacking the Unit

When the equipment reaches its destination it should be unpacked to determine if any damage has occurred during shipment. Any visible damage should be noted on the carrier's freight bill and a suitable claim filed.

## PC Indoor Unit Placement

Some thought as to how the unit is placed will make air ductwork and piping connections much simpler. See diagram [002297PDG](#) later in this manual for an example placement.

The front access panels should remain clear of obstruction for a distance of **two feet** to facilitate servicing and general maintenance. No access is required on the back side. Ensure the unit is level to eliminate any possible condensate draining issues.

Raising the unit off the floor, as shown in the diagram, can make connections easier. **Room for the condensate to drain under gravity, either to the pool or to a condensate pump, must be provided; and condensate drain connections are at the bottom of the unit.** An anti-vibration pad, available as an accessory, or a piece of 2" styrofoam should be placed under the unit. Be careful not to run piping in front of the filter rack access cover, since access is required in order to change the air filter.

The PC unit is available in top, side/end, and bottom air discharge configurations from the factory; be sure to plan ductwork and order the most appropriate configuration. It is suggested that supply ductwork be kept low, and air return grill high for most effective and efficient operation. See the [Ductwork](#) section later in this manual for details.

Normally, water will be circulated continuously through the pool conditioner by the pool filter pump (PC-T only). A pool water bypass should not be required. The PC unit can control the pool pump if required.



## Optional AC2 Outdoor Unit Placement

The accessory AC2 unit must be placed outdoors, with the fan pointing away from the building. It should be at least **12 inches (30 cm)** away from the building or other obstructions on the back and sides for unimpeded return airflow. There should be little or no obstruction in the fan (front) direction for at least **10 feet (3 m)**, otherwise airflow and therefore overall performance will be reduced.

In addition, there should be at least **two feet (0.6 m)** of clearance on the electrical box and refrigeration piping side of the unit to facilitate servicing and general maintenance.

If there is any expectation that heat rejection (air cooling) mode will be required while there is snow on the ground, the outdoor unit must be mounted high enough so that it remains clear of snow and ice at all times. Since this is not likely, the unit may be mounted at ground level in most cases. If required, two different leg kits which add either 15" (38 cm) or 30" (76 cm) of additional height are available as an accessories.

The AC2 **must be bolted down** to prevent a tipping hazard.

Note that **no field installed filter-dryer is required**, since one is included in the indoor unit.



**IMPORTANT NOTE: The line set between the indoor and outdoor units must not exceed 70 ft (21 m) in length.**



## Outdoor Fan Speed Reduction

Should fan noise be a concern, for example if the outdoor unit is mounted near a frequently open window, the outdoor fan speed can be reduced (up to a maximum of 25%). This should only be done if necessary, since a small loss in efficiency will result.

The fan speed can be reduced via the LCD (see [LCD Interface & Menus](#) section) or PC App (see [PC Application](#) section).

## Optional Ground Loop Heat Exchanger

If rejecting heat to a geothermal ground loop, the insulated refrigerant to water heat exchanger ("water coil") and its associated water/antifreeze circulator should be placed in a location convenient to the PC unit and ground loop connections.

Coaxial coils from Maritime Geothermal Ltd. are not supplied in a cabinet, and should be affixed to a vertical surface using the attached mounting bar. See diagram in [Piping](#) chapter and *Application Table* on page 3.

## Air Thermostat Placement

The communicating air thermostat should be placed in the pool room in an accessible location, **at least 48 inches above floor level**.

This is to be sure the sensor is not subjected to **chloramides**, which can form closer to floor level if pool room chemistry becomes unbalanced. Chloramides can lead to rapid failure of the sensor inside the thermostat, necessitating sensor replacement. See [Repair Procedures](#) chapter for replacement of sensor.

## Plenum Heater Installation

Plenum heater should be installed externally in the air discharge duct outside the PC cabinet in a manner that allows all of the airflow to pass through it, to prevent any hot spots in the heater elements. It should be mounted in a straight section of ductwork, and not immediately downstream of a duct elbow. Note that an air velocity of **400 ft/min** or greater is required to prevent high temperature shutdowns of the plenum heater, which will be achieved if mounted in an appropriate position.

Mount the plenum heater in the side of the duct, not the bottom, to prevent duct condensation from entering the plenum heater's electrical box.

# Wiring

## PC-Series Power Supply Connections

The unit has a concentric 1.093" / 0.875" knockout for power supply connection to the electrical box. There are also two 7/8" knockouts and a 1/2" opening with plastic grommet (grommet hole is 3/8") for connections to the supplied air thermostat, optional external pool water aquastat, and power and signal connections to optional outdoor condensing unit.

A schematic diagram (SCH) and electrical box layout diagram (ELB) can be found on the electrical box cover of the unit as well as in the [Model Specific Information](#) section of this manual. The Electrical Tables in the [Model Specific Information](#) section contain information about the size of wire for the connections, as well as the recommended breaker size.



**NOTE: A properly qualified electrician should be retained for all connections to the unit and associated controls.**



**IMPORTANT NOTE FOR 3-PHASE UNITS: If on startup compressor is noisy and not pumping, reverse L1 and L2 supply wires.**

Line	Description	Voltages
L1	Line 1	All
L2	Line 2	All
L3	Line 3	3-phase only
N	Neutral	460-3-60, 380-3-50 only
GND	Ground	All (connect to ground lug)

## Control Transformer

The rest of the low voltage controls, including the control board, are powered by a 100VA class II transformer. 208/230-1-60 and 208-3-60 models have a resettable breaker on the secondary side for circuit protection. Should the breaker trip, locate and correct the problem and then reset the breaker by pressing in on it.

All other voltage models have primary and secondary fuses for circuit protection.

Voltage	Low Voltage Circuit Protection
(1) 208/230-1-60	Resettable breaker on transformer
(2) 208-3-60	
(4) 460-3-60	Primary / Secondary fuses
(6) 220-1-50	
(7) 380-3-50	



**IMPORTANT NOTE: For 208/230VAC-1-60 units, if connecting to 208VAC power supply move the red wire connected to the 240 terminal of the transformer to the 208 terminal.**

## Auxiliary Plenum Heater: Power Supply Connections

Auxiliary heat for the pool room air will usually be provided by the included electric duct heater (plenum heater), installed in the air discharge ductwork outside the PC unit. The plenum heater will have its own breaker and power supply wire. The Electrical Tables in the [Model Specific Information](#) section

contain information about the size of wire for the connections, as well as the recommended breaker size.

## Auxiliary Plenum Heater: Signal Connections

The PC unit has two dry contacts to control the 2 stages of the plenum heater. These dry contacts can also be used to control other types of auxiliary air heat. Note that dry contacts are intended to activate equipment that has its own 24VAC transformer; if equipment does not have its own transformer, one will need to be installed in an external electrical box.

Connect the terminals on the PC's terminal strip to the matching terminals on the plenum heater's control board using an 18-3 cable.

**NOTE:** If there is a jumper between terminals 1 and 2 on the plenum heater's control board, remove jumper and discard it.

Signal	Description
CP	Common
1	Dry contact for auxiliary heat stage 1
2	Dry contact for auxiliary heat stage 2

Use a 3-conductor 18ga cable.

## Pool Pump Signal Connections *(PC-T only)*

In most installations, the pool pump will be always on, to constantly circulate pool water through the filter. So there will always be pool water circulation through the PC unit, with no controls required.

However, the PC unit does have a dry contact to relay an external 24VAC signal to activate the pool pump contactor when the PC requires pool water flow; that is, in pool water heating mode. The 24VAC transformer and contactor will be contained in an external electrical box. See the following wiring connection diagram [002298CDG](#).

Connect the 24VAC signal to be relayed to terminals CP1 and CP2 on the PC unit's terminal strip with an 18-2 cable.

Signal	Description
CP1	Dry contacts for pool pump contactor
CP2	

Use a 2-conductor 18ga cable.

## Pool Flow Switch Connections *(PC-T only)*

Previously an accessory, a flow switch is now **standard equipment**.

This is advantageous if the pool pump is not always on and the PC can't be given control of the pool pump. Operation in pool water heat mode will be delayed until the flow switch is closed.

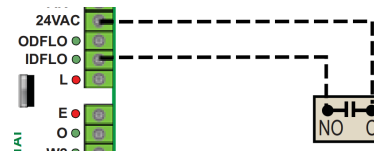

## Accessory AC2-Series Outdoor Unit: Power Supply Connections

The AC2 outdoor unit is powered from the PC unit. The power supply for the AC2 unit is 208 to 277VAC, 50/60Hz. The PC and AC2 units have matching terminal strips for these connections. Use a two conductor, minimum 14ga **outdoor rated cable** for this connection. Refer to diagram [002298CDG](#).

Line	Description
L1	Supply line
L2	Supply line
GND	Ground

Use a two conductor outdoor rated 14ga minimum cable.



**IMPORTANT NOTE:** Most codes require a disconnect switch visible and/or reachable from the outdoor unit to be installed in the power supply cable. If the switch has fuses or breakers they must be no more than 10A.



**OUTDOOR DISCONNECT SWITCH IS A SAFETY DEVICE ONLY.** Turn off breaker to indoor unit before servicing to avoid costly damage to electronic control board.

## Accessory AC2-Series Outdoor Unit: Signal Connections

The speed of the fan in the optional AC2 outdoor unit is controlled by the control board in the indoor PC unit. In addition, the PC has an auto-detect function for the outdoor unit, so that no settings need to be changed if installing the optional AC2 (enabling heat rejection/air cooling mode). Therefore, communication wiring is required.

The PC and AC2 units have matching terminal strip signals for these connections. Connections are labeled PWM+, DET, and DET (the two DET terminals being interchangeable). Use 3 conductors of the included 18-8 **shielded outdoor rated cable** for this connection. If longer than 50 ft is required, inform when ordering unit. Refer to diagram [002298CDG](#).

Signal	Description
PWM+	Outdoor Fan Control
DET	Auto-detection of AC2 unit
DET	

Use the included shielded 8-conductor outdoor rated 18ga cable.

## Alternative Heat Rejection Methods: Connections

As an alternative to the AC2 outdoor unit, heat maybe rejected to:

1. An existing geothermal ground loop
2. An open loop (well water)

See diagrams in the [Piping](#) chapter for details of the wiring and piping for these methods.

## Air Thermostat Connections

The pool conditioner unit comes with its required air thermostat, which is the **BAPI Stat4** (model **BA/BS4MBC-G-H2-FN-Z** or close variation). This is both a communicating room sensor for air temperature and humidity, and also a user interface to change the air temperature and humidity setpoints. It communicates with the PC unit via the MODBUS protocol on an RS485 bus using a twisted wire pair. There are also two power wires required, so the thermostat should be connected using a double-twisted-pair wire. 50 ft of this wire is supplied along with the thermostat; be sure to order a longer wire if required.

Using this wire, connect the terminals on the terminal strip in the PC unit to the BAPI Stat4 as follows. Also see connection diagram [002298CDG](#) following, and PC wiring (SCH) diagrams in the [Model Specific Information](#) section or on the electrical box cover.

The air thermostat is normally supplied with correct settings from the factory. If thermostat has not been set up, follow the setup instructions in the [Operation](#) chapter.

PC terminal strip	BAPI Stat4	Wire	Description
A	NET A	TWISTED PAIR 1	Communication +
B	NET B		Communication -
24VDC	POWER	TWISTED PAIR 2	24VDC power
GND	GND		ground

Use the included double twisted pair cable.

## Pool Aux. Heat Connections (PC-T only)

For commercial applications where auxiliary pool heat is required, this can be controlled via the PC's hydronic Auxiliary/ Stage 2 setpoint and dry contacts **D1-D2**.

Signal	Description
D1	Dry contacts for pool auxiliary heat
D2	

Use a 2-conductor 18ga cable.

## Disable Switch (field installed)

A switch to disable demand from the control system may be installed. On control board, jumper COM\_IN to GND, and toggle 12VDC to IN\_SPARE to disable. See the main wiring diagram in the [Model Specific Information](#) section.

## Accessory Connections

In most installations, accessories that are not already described will not be required. Other available accessories include:

- **External pool water temperature sensor**, replacing the internal water OUT line temperature sensor for use with the PC control board's Setpoint Control routine. This is HTS/CTS Setpoint Control, described later.
- **External dry contact to reduce air flow** by the AR percent factor
- **External dry contact, switch, or jumper R to G** at lower right of control board to activate **56% airflow** even when there is no demand on PC unit.

See the PC wiring (SCH) diagrams in the [Model Specific Information](#) section or on the electrical box cover.

# Typical PC-Series Wiring Connections

## POOL CONDITIONER (PC) ELECTRICAL BOX

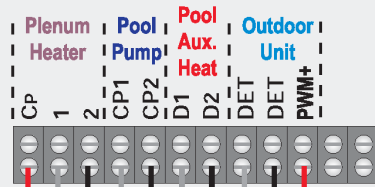

Outdoor Unit Power Supply  
GND L1 L2

Air Thermostat Connection  
24VAC GND A B

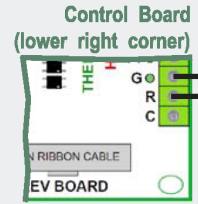

OUTDOOR-RATED 14-2 CABLE

Disconnect Switch (within view of outdoor unit)

OUTDOOR CONDENSER (AC2) ELECTRICAL BOX

L1 Outdoor Unit Power Connections  
L2  
GND  
PWM+ Outdoor Unit Signal Connections  
DET  
DET

OUTDOOR-RATED 18-3/18-8 CABLE

SHIELDED, DOUBLE TWISTED PAIR CABLE (supplied with PC unit)

DO NOT CONNECT SHIELD GROUND WIRE TO THERMOSTAT (Cut it off close to cable)

CABLE SHIELD



COMMUNICATING THERMOSTAT (required, supplied with PC unit)

18-2 CABLE

connection not normally required



18-2 CABLE

connection not normally required; see note

18-3 CABLE

PLENUM HEATER ELECTRICAL BOX

2 Remove jumper 1-2 if present  
1  
C

LINE VOLTAGE  
L2  
L1  
GND

EXTERNAL ELECTRICAL BOX

14-2 BX CABLE

TRANSFORMER

24VAC  
24VAC GND

CONTACTOR

NOTE: Normally pool pump is wired to run continuously, to supply pool water to the filter. Use the arrangement shown only if using a pump which is to be controlled by the PC unit.

POOL PUMP

14-2 BX CABLE

03	000326	Dan Rheault	Dan Rheault	1-Jan-2025	Drawn By Dan Rheault	Date 11-Apr-2018	MARITIME GEOTHERMAL LTD. 170 Plantation Rd. Petitcodiac, NB E4Z 6H4
02	000321	Dan Rheault	Dan Rheault	1-May-2024	Checked By Dan Rheault	Date 11-Apr-2018	
01	ISSUE 03	Dan Rheault	Dan Rheault	10-May-2023	Approved By (ENG)	Date	Drawing Name Typical PC-Series Wiring Connections
01	ISSUE 02	Dan Rheault	Dan Rheault	27-Sep-2021	Approved By (MFG)	Date	
01	Initial Release	Dan Rheault	Dan Rheault	11-Apr-2018	Approved By	Date	
REV	ECO #	IMPL BY	APVD BY	DATE	Approved By	Date	Size A
							Drawing Number 002298CDG
							Drawing Rev 03
							Sheet 1 of 1

go to TABLE OF CONTENTS

# Piping

## Pool Water Lines *(PC-T only)*

The connections for the pool loop are 2" PVC unions, rigidly fixed to the cabinet to prevent relative movement and possible resulting damage to interior piping. They are labelled as INDOOR IN and INDOOR OUT.

Piping for a typical system is shown in following diagram [002297PDG](#). This diagram shows all of the recommended components as well as where they should be placed, although placement will vary according to layout of duct system and space in mechanical room. The unions allow access to the co-axial heat exchanger should it require cleaning, and quick disconnect of PC unit.

**NOTE:** Care should be taken when routing the water lines to ensure that adequate access to the unit is maintained so as to not compromise ease of serviceability, particularly access to both side doors and the air filter change cover.

## Condensate Drain

The unit comes equipped with two 3/4" female NPT drain connections, labeled "Condensate Drain". This drain allows the condensate which forms during the air-conditioning cycle to be removed from the unit. The drain should be connected as per local codes. During high humidity weather, there could be as much as 25 gallons of water formed per day.

The condensate drain requires an external trap. It is recommended to use a pre-made trap with cleanout like that shown in the diagram. The drain should be back to the pool where allowed by codes, in order to reduce the amount of make-up water required for the pool. An external condensate pump may be installed if there is not sufficient slope to drain condensate under gravity to its destination.

**NOTE:** The condensate drain operates by gravity. Ensure the unit is mounted high enough to allow the condensate to flow without overflowing the internal drip tray located at the bottom of the unit.

To avoid overflow of the condensate pan, the drain line and trap should be inspected periodically to ensure they are not plugged with accumulated debris.

## Simultaneous Pool/Hot Tub Heating

*(PC-T only)*

The following diagram [001824PDG](#) shows two suggested methods of heating both a pool and a hot tub with the PC unit.

Note that if heating two pools of differing temperatures using a parallel arrangement as in section 1 of the diagram, external aquastat(s) will be needed to control the pool water heating demand, since the internal Setpoint Control routine only has one setpoint. Also, the flow will need to be set using the procedure outlined on diagram [002297PDG](#), but flow through the pool and hot tub will need to be set separately because of the different water temperatures.

If using an indirect pool heating arrangement as shown in section 2, the internal Setpoint Control routine can be used.

Alternatively, the PC unit can be used to heat the pool, while the hot tub can be heated by a different pool heating device dedicated for that purpose.

## Air Conditioning with Ground Loop Coil

As mentioned earlier, there are two different devices which can be connected for heat rejection to perform air conditioning: an accessory AC2-series outdoor unit (which has only refrigerant line set connections, see later chapter) or a **heat exchanger / water coil for connection to an existing geothermal ground loop** (which requires refrigerant line set connections outlined in a later chapter, and requires ground loop piping).

See following diagram [002641PDG](#) for geothermal ground loop coil and circulator connection. Suitable coils are available from Maritime Geothermal Ltd; see *Application Table* on page 3.

The refrigerant line set connections are described in a following chapter.

Because there is no outdoor unit, a wire jumper from **DET-DET** is required to enable air cooling mode.

## Air Conditioning with Open Loop Water

A third option to enable heat rejection for air conditioning purposes (the others being an AC2-series outdoor unit or an existing geothermal ground loop) is to use open loop well water. This will require a place to drain the water to, like a floor drain or return well.

See following diagram [001045CDG](#).

A pair of 24VAC 3-way valves can be placed in the IN and OUT pool water lines connected to the unit, as shown in the diagram on following page. Connect the IN valve common port to the PC IN port, the NO port to the supply from the pool, and the NC port to a clean cold water source. It may also be necessary to install a regulating valve (e.g. hand valve, dose valve) to restrict the flow to obtain the recommended discharge pressure of 350-400PSIG. Connect the OUT valve common port to the PC OUT port, the NO port to the return line to the pool, and the NC port to a suitable drain.

The valves can be controlled by the **L1** output from the PC's control board, as shown. L1 will output 24VAC whenever the PC unit enters air cooling mode. Note the current limit of **500mA** from L1; if 3-way valve current draw exceeds 500mA, or if 3 way valves with non-24VAC coils are used, a separate power supply switched by a 24VAC relay is required.

No jumper from **DET-DET** should be installed. In the PC App's *View*—>*Control Panel*, **Rejection Select** should be set to **Pool**.

## Typical Loop Connections - PC Series

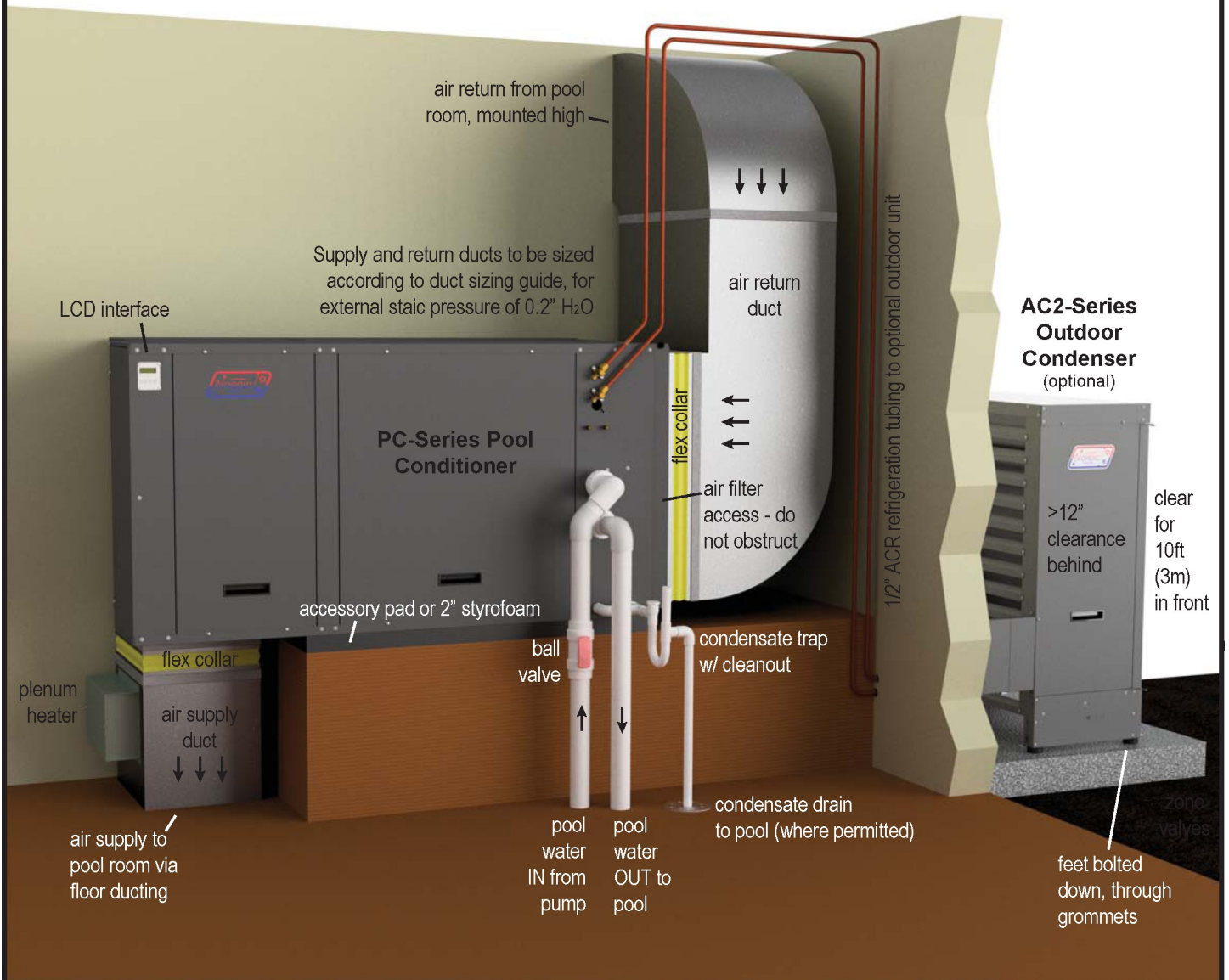

There are multiple valid connection methods or details which differ from those shown, including:

- supply duct on the left end (side) or top of the PC unit, as factory options
- piping routed differently from that shown, or different piping & component types.
- use of well water or a ground loop coil to reject heat to rather than an outdoor condenser.

					Drawn By <b>Dan Rheault</b> Date <b>3-Apr-2018</b>	<b>MARITIME GEOTHERMAL LTD.</b> P.O. Box 2555 170 Plantation Rd. Pettitcodiac, NB CANADA E4Z 6H4				
					Checked By <b>Dan Rheault</b> Date <b>3-Apr-2018</b>					
03	000325	Dan Rheault	Dan Rheault	19-Sep-2024	Eng. Approved By	Date				
02	000271	Dan Rheault	Dan Rheault	6-Mar-2019	Mfg. Approved By	Date				
01	Initial Rel.	Dan Rheault	Dan Rheault	3-Apr-2018	Approved By	Date				
REV	ECO#	IMPL BY	APVD BY	DATE	Size	LET				
						Drawing Name	Drawing Number	Revision	Sheet	
						<b>Typical Loop Connections - PC Series</b>		002297PDG	03	1 / 1



## 1. PC-Series Parallel Piping to Pool & Hot Tub

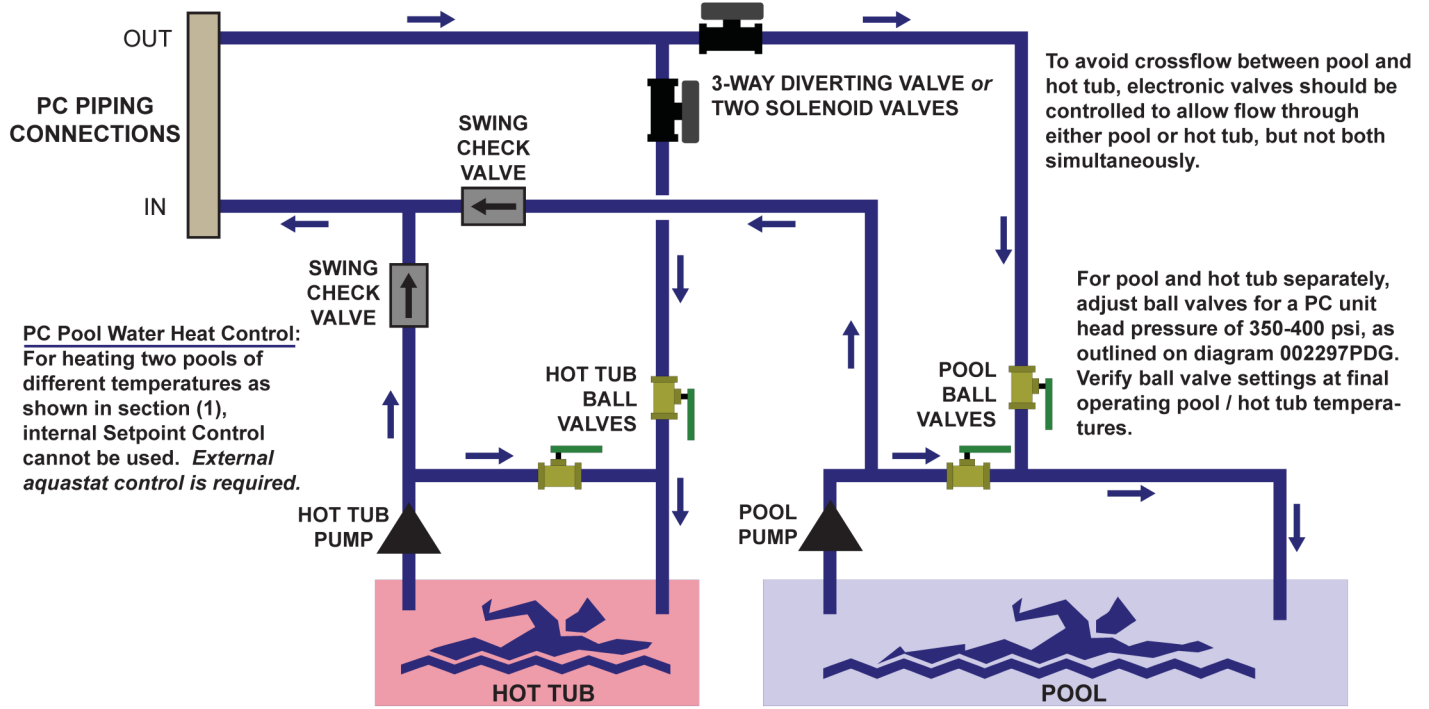

## 2. PC-Series Piping to Hot Tub with Heat Exchange to Pool

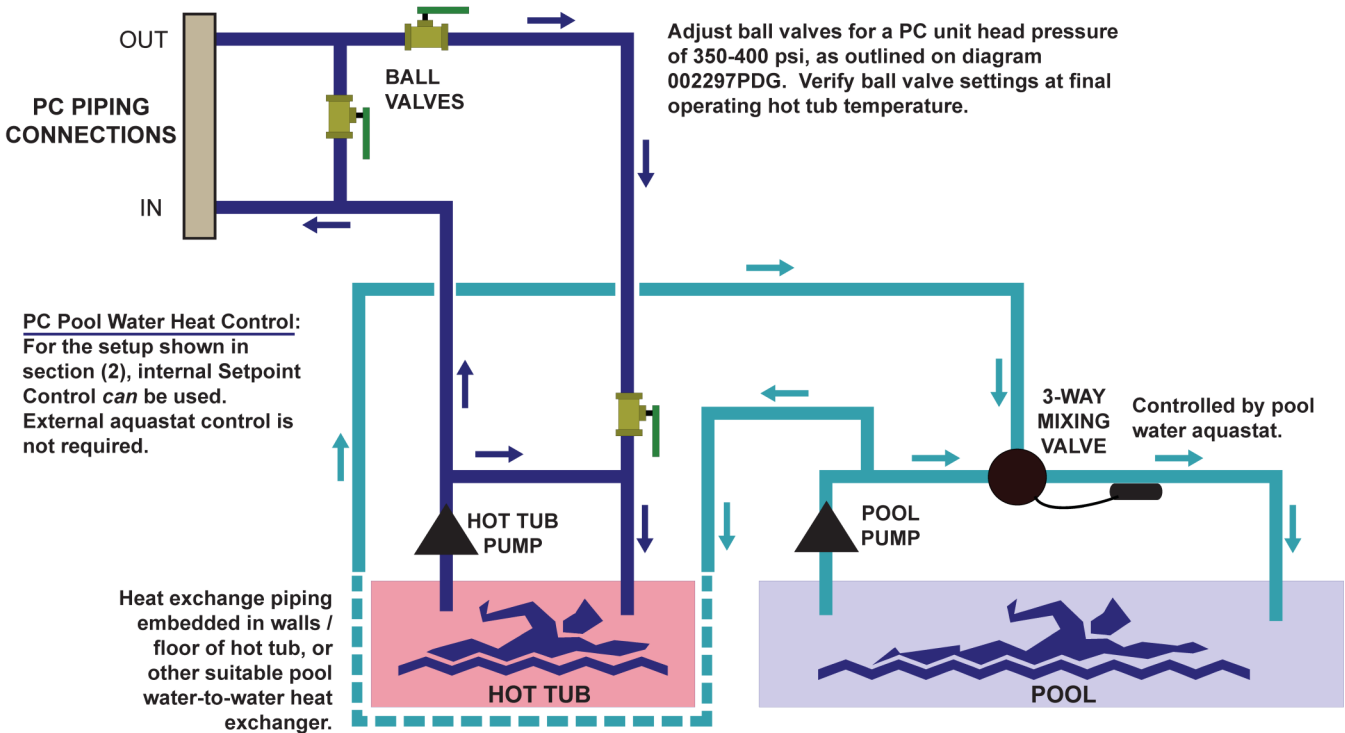

02	000236	Dan Rheault	Dan Rheault	26-Apr-2018	Drawn By Dan Rheault Date 3-Dec-2013 Checked By Dan Rheault Date 3-Dec-2013 Eng. Approved By Date Mfg. Approved By Date Approved By Date	<b>MARITIME GEOTHERMAL LTD.</b> P.O. Box 2555 170 Plantation Rd. Pettitcodiac, NB CANADA E4Z 6H4	Drawing Name		
01	Initial Rel.	Dan Rheault	Dan Rheault	3-Dec-2013			PC-Series Connection to Pool & Hot Tub		
REV	ECO#	IMPL BY	APVD BY	DATE			Size LET	Drawing Number 001824PDG	Revision 02

# PC-Series Connections for Ground Loop Heat Rejection

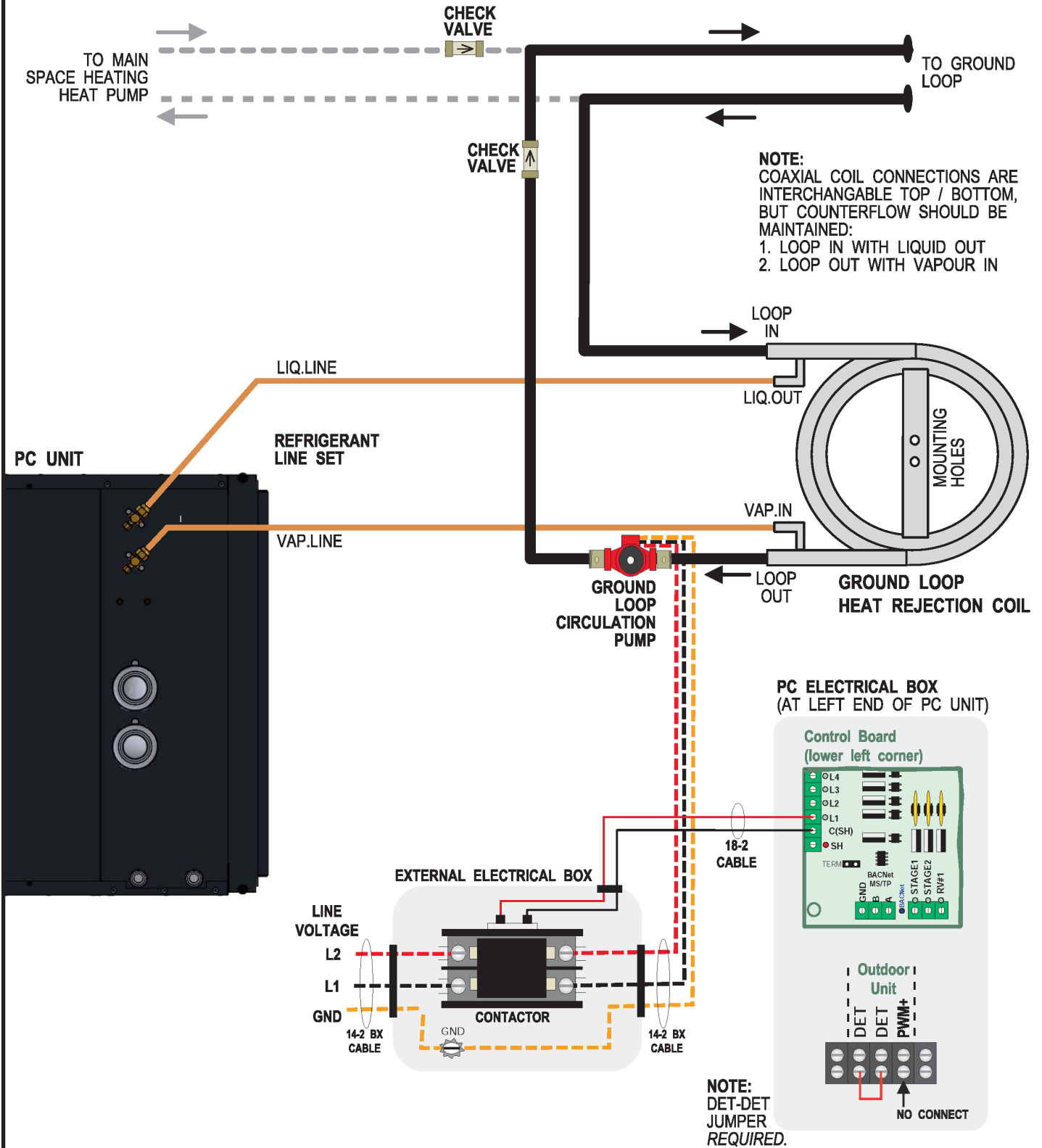

					Drawn By Dan Rheault	Date 19-May-2023	<b>MARITIME GEOTHERMAL LTD.</b> 170 Plantation Rd. Petitcodiac, NB E4Z 6H4
					Checked By Dan Rheault	Date 19-May-2023	
					Approved By Dan Rheault	Date 19-May-2023	
					Approved By (ENG)	Date	Drawing Name PC-Series Connections for Ground Loop Heat Rejection
					Approved By (MFG)	Date	Size A
01	Initial Release	D. RHEAULT	D. RHEAULT	19-May-2023	Approved By	Date	Drawing Number 002641CDG
REV	ECO #	IMPL BY	APVD BY	DATE	Approved By	Date	REV 01
							SHEET 1 of 1

go to TABLE OF CONTENTS

# PC-Series Connections for Open Loop Heat Rejection

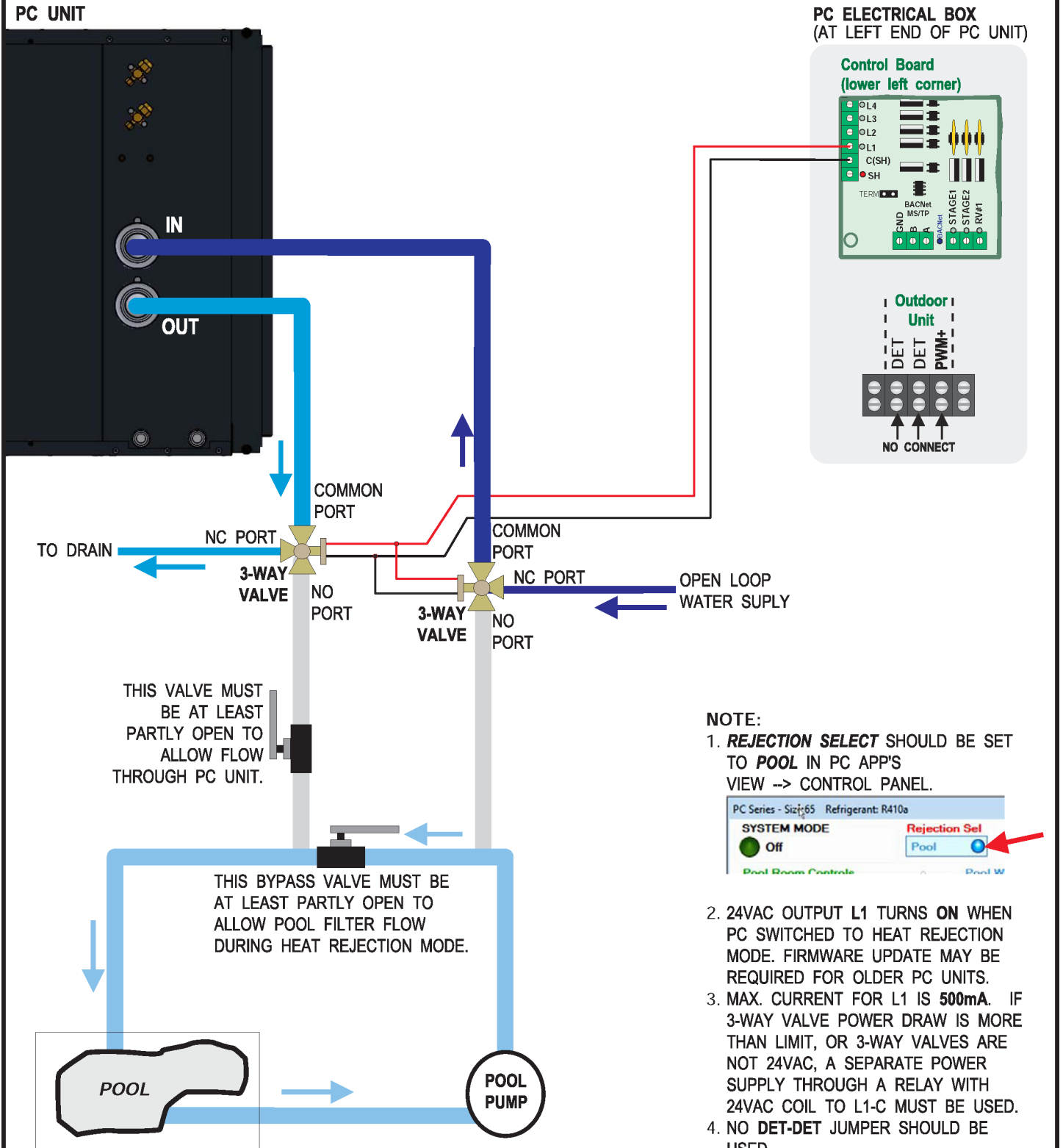

					Drawn By Chris Geddes	Date 25 MAY 09	<b>MARITIME GEOTHERMAL LTD.</b>	170 Plantation Rd Petitcodiac, NB E4Z 6H4		
02	ISSUE 02	D. RHEAULT	D. RHEAULT	19-May-2023	Checked By Chris Geddes	Date 25 MAY 09		Drawing Name	PC-Series Connections for Open Loop Heat Rejection	
02	000284	D. RHEAULT	D. RHEAULT	27-Sep-2021	Approved By Chris Geddes	Date 25 MAY 09	Size	Drawing Number	REV	SHEET
01	Initial Release	C. GEDDES	C. GEDDES	25-May-2009	Approved By	Date	A	001045CDG	02(12)	1 of 1
REV	ECO #	IMPL BY	APVD BY	DATE	Approved By	Date				

go to TABLE OF CONTENTS

# Ductwork

## Duct Systems - General

The duct system should be constructed of standard galvanized sheet metal, such as would be used for a typical residential heating system. All joints should be sealed with an approved duct sealant to ensure there are no leaks in the system.

A duct system capable of supplying the required air flow is of utmost importance. Maritime Geothermal Ltd. recommends that the static pressure be kept below 0.2 inches of water total.

It is **VERY IMPORTANT** that all turns in both the supply trunks and the return trunks be made with **TURNING RADII**. Air acts like a fluid and, just like water, pressure drop is increased when air is forced to change direction rapidly around a sharp or irregular corner.

It is recommended that flexible collars be used to connect the main trunks to the unit. This helps prevent any vibrations from travelling down the ductwork.

The first 5-10 feet of the main supply trunks may be insulated with acoustical duct insulation to further inhibit any noise from the unit from travelling down the ductwork.

## Supply Duct System

The care and attention devoted to setting up the air distribution system can make or break any indoor pool conditioning system. Important factors to consider are:

- 1) Sufficient air must be moved within the pool enclosure to satisfy the requirements of both the occupants of the room and the pool conditioner, with maximum flow directed over the outside windows and doors and minimum flow directly over the exposed surface of the pool itself.
- 2) To prevent air stagnation and stratification the system must provide at least 4 to 8 room air changes per hour.
- 3) The PC unit supply air ductwork must be adequately sized to handle 1200 to 2400 cfm of air (depending on the model size) with no more than 0.20" H<sub>2</sub>O of external static pressure. See following table for a duct sizing guide that can be used to select adequate duct sizes.
- 4) An in-floor duct system is usually the most effective method of supplying air to the room (see following diagram). Distribution of the conditioned air will be most effective if the air is released from the floor and allowed to rise upwards over the glass surfaces. It is important to try and blanket the entire surface of glass windows and metal doors with a film of dry air from the pool conditioner to prevent accumulation of condensation at the corners or bottom of the glass. If a ceiling ducted system is chosen, then the supply air should be of sufficient velocity to ensure that air flows over the glass all the way down to the bottom of the window.
- 5) Long, narrow supply grills should be placed under all glass areas exposed to outside temperatures for optimum operation.
- 6) Additional care should be taken to ensure that airflow is not directed across the pool surface since moisture loss from the pool water will be greatly increased under these conditions.
- 7) If a floor distribution system is not possible then ceiling ducts should be positioned to blow down over the exposed glassed areas of the room perimeter. It may be necessary to increase the airflow using the PC App to accomplish the more difficult task of forcing the air exiting the supply ducts down over the glass.

## Return Duct System

The air inlet of the return duct system should ideally be placed 10 to 15 ft above the pool level. Placing this duct inlet in an elevated position will ensure that air travels in an upward fashion if it is introduced from the floor. An airflow pattern which causes minimum airflow across the pool surface should be used to minimize evaporation from the pool surface. Large volumes of air travelling near the pool surface can also cause swimmers to feel cold whenever they emerge from the water.

## Plenum Heater

As mentioned in previous sections, a plenum heater should be installed to provide pool room air auxiliary heat.

The plenum heater should be mounted in the supply duct in a manner that allows all or most of the airflow to pass through it to prevent any hot spots in the heater elements. If the elements overheat due to experiencing low airflow, they will shut down on thermal overload controls in the plenum heater, and sporadic operation resulting in low heat output will occur.

The plenum heater should be placed downstream of the flex collar as shown in diagram **002297PDG**, or at least 12" away from the flex collar if placed upstream. Duct insulation should not be placed within 12" of the heater elements.

**FIGURE 1 - Floor Supply Ducts With Elevated Return**

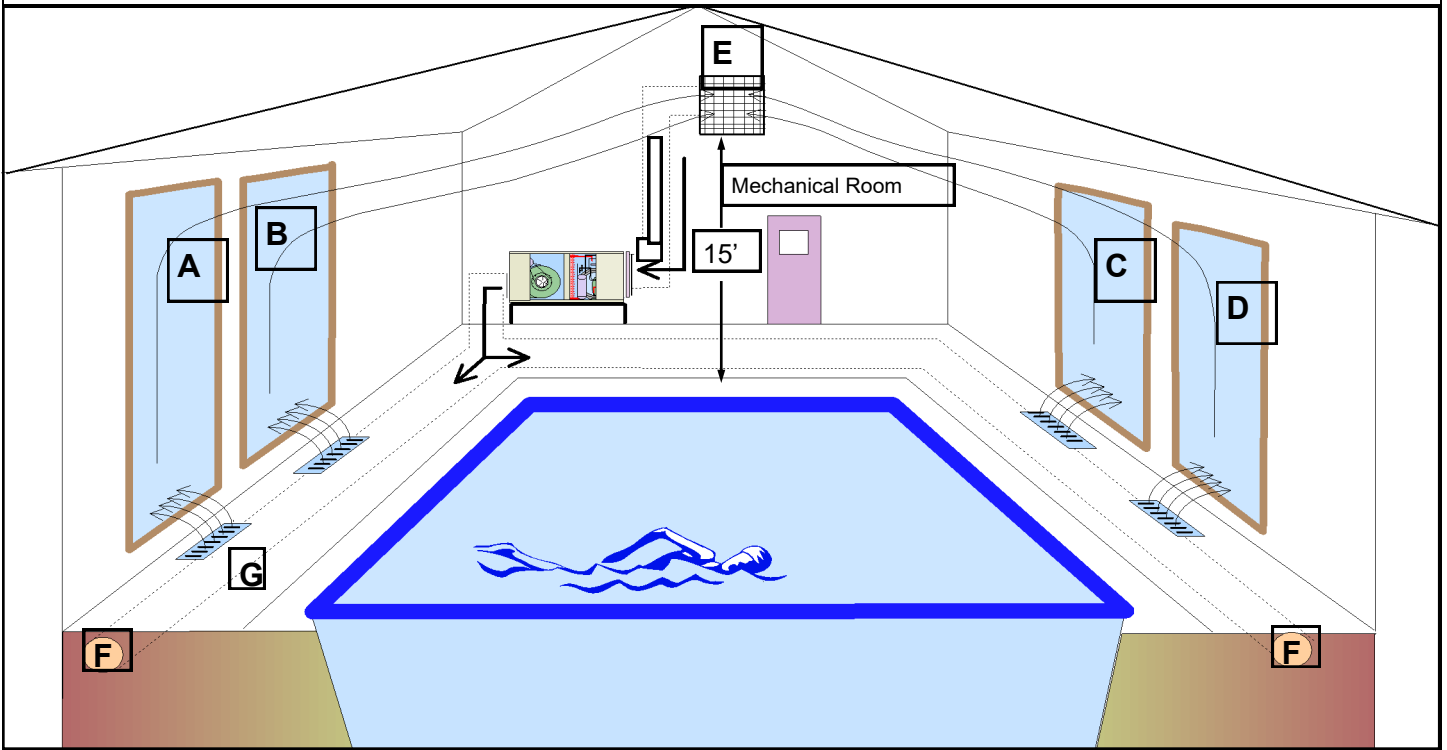

The diagram above shows a common technique for installing supply ducts in the pool room. Dry air is directed upward over the windows **A**, **B**, **C** and **D**. As the air picks up moisture from the pool room, it is drawn towards the return air grill **E** where it re-enters the pool conditioner. Air is released over the glass and drawn to the return air grill of the PC with as little travel as possible over the pool surface.

Supply ducts "**F**" are located below the concrete pool decking and insulated with waterproof closed cell or styrofoam insulation so that the air at each supply grill is at approximately the same temperature.

Floor diffusers "**G**" should be placed close to the windows and be wide enough to direct air over the entire glass surface to ensure that no condensation occurs in corners or on the lower levels of the glass.

**FIGURE 2 - Elevated Supply Ducts With Elevated Return**

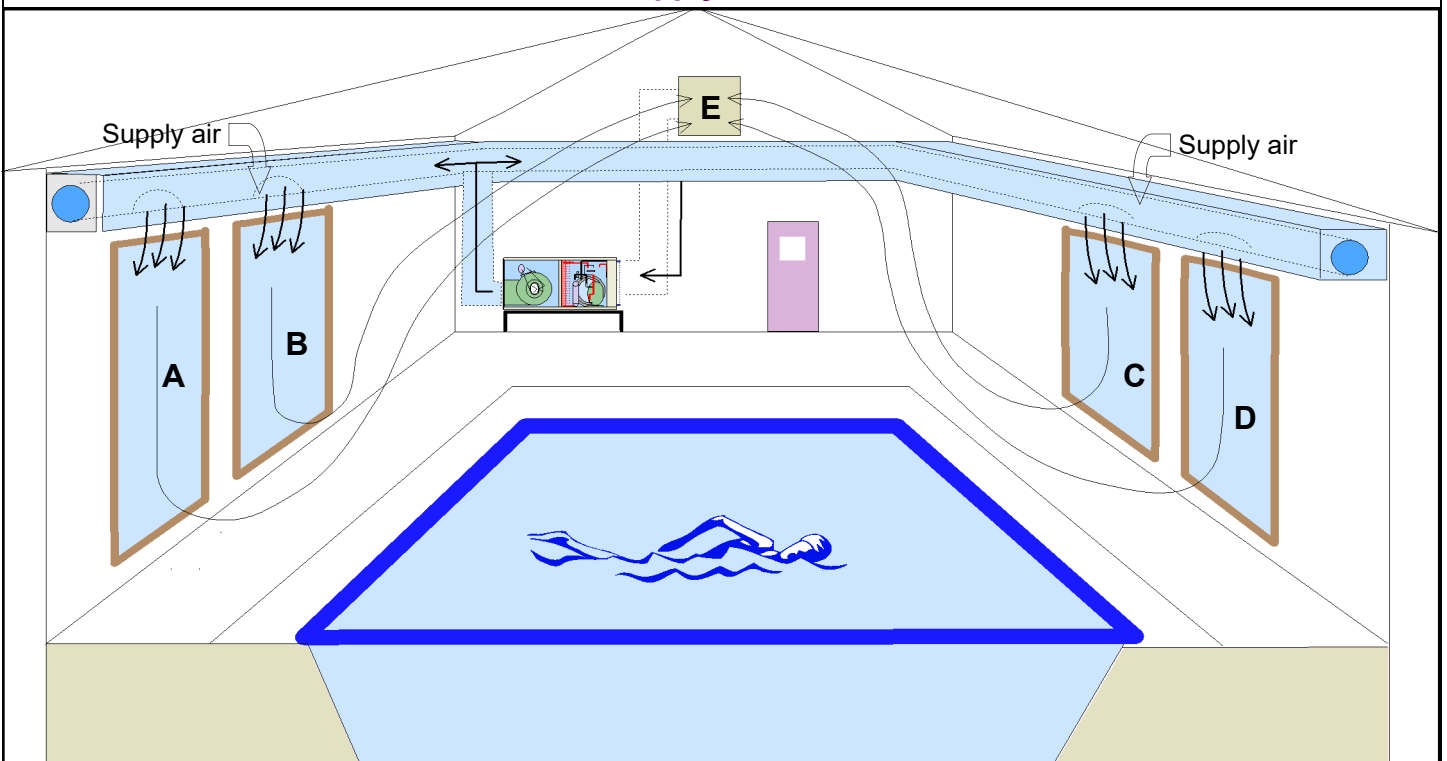

The diagram above shows another possible technique for installing supply ducts in the pool room. Dry air is directed downward over the windows **A**, **B**, **C** and **D**. As the air picks up moisture from the pool room it is drawn towards the return air grill **E** where it re-enters the pool conditioner. In each case air is released over the glass and drawn to the return air grill of the PC with as little travel as possible over the pool surface.

**TABLE 17 - Duct Sizing Guide (external static of 0.20" H<sub>2</sub>O)**

Airflow (cfm)	Minimum Duct Area (sq.in)	Diameter (in)	Rectangular Equivalents (in)						Return Air Diameter (in)	Airflow (L/s)
37	20	5	2.25 x 10	3 x 8	3.5 x 6	4 x 5.5	5 x 5		← 5	17
63	20	5	2.25 x 10	3 x 8	3.5 x 6	4 x 5.5	5 x 5		↙ 6	30
100	28	6	3.25 x 10	4 x 8	5 x 6	5.5 x 5.5	6 x 6		← 7	47
152	38	7	3.25 x 14	4 x 11	5 x 8.5	6 x 7	6.5 x 6.5		↙ 8	72
212	50	8	4 x 15	5 x 12	6 x 10	7 x 8	8 x 8		← 9	100
226	50	8	4 x 15	5 x 12	6 x 10	7 x 8	8 x 8		↙ 10	107
277	64	9	5 x 15	6 x 12	7 x 10	8 x 9	8.5 x 8.5		← 10	131
304	64	9	5 x 15	6 x 12	7 x 10	8 x 9	8.5 x 8.5		↙ 12	143
393	79	10	6 x 15	7 x 13	8 x 11	9 x 10	9.5 x 9.5		← 12	185
411	113	12	7 x 18	8 x 16	9 x 14	10 x 12	11 x 11		← 12	194
655	113	12	7 x 18	8 x 16	9 x 14	10 x 12	11 x 11		↙ 14	309
680	154	14	8 x 22	9 x 19	10 x 17	11 x 15	12 x 14	13 x 13	← 14	321
995	154	14	8 x 22	9 x 19	10 x 17	11 x 15	12 x 14	13 x 13	↙ 16	470
1325	201	16	8 x 30	10 x 22	12 x 18	14 x 16	15 x 15		← 18	625
1450	201	16	8 x 30	10 x 22	12 x 18	14 x 16	15 x 15		↙ 20	684
1750	254	18	8 x 40	10 x 30	12 x 24	14 x 20	16 x 17	16.5 x 16.5	← 20	826
2000	254	18	8 x 40	10 x 30	12 x 24	14 x 20	16 x 17	16.5 x 16.5	↙ 22	944
2250	314	20	10 x 38	12 x 30	14 x 26	16 x 22	18 x 19	18.5 x 18.5	← 22	1062
2600	314	20	10 x 38	12 x 30	14 x 26	16 x 22	18 x 19	18.5 x 18.5	↙ 24	1227
2900	380	22	12 x 36	14 x 30	16 x 26	18 x 23	20 x 20		← 24	1369
3400	380	22	12 x 36	14 x 30	16 x 26	18 x 23	20 x 20		↙ 26	1605
3600	452	24	14 x 38	16 x 32	18 x 28	20 x 25	22 x 22		← 26	1699
4300	452	24	14 x 38	16 x 32	18 x 28	20 x 25	22 x 22		↙ 28	2029
5250	531	26	16 x 38	18 x 32	20 x 30	22 x 24	24 x 24		← 30	2478
6125	616	28	18 x 38	20 x 34	22 x 30	24 x 28	26 x 26		↙ 32	2891
6500	616	28	18 x 38	20 x 34	22 x 30	24 x 28	26 x 26		← 34	3068
7250	707	30	20 x 40	22 x 38	24 x 32	26 x 30	28 x 28		↙ 34	3422
7800	707	30	20 x 40	22 x 38	24 x 32	26 x 30	28 x 28		← 36	3681
8500	804	32	22 x 40	24 x 38	26 x 34	28 x 32	30 x 30		↙ 36	4012
9200	804	32	22 x 40	24 x 38	26 x 34	28 x 32	30 x 30		← 38	4342
9800	908	34	24 x 42	25 x 40	26 x 38	28 x 34	30 x 32	31 x 31	↙ 38	4625
10900	908	34	24 x 42	25 x 40	26 x 38	28 x 34	30 x 32	31 x 31	← 40	5144
			28 x 40	30 x 36	32 x 34	33 x 33			↙	
			30 x 42	32 x 38	34 x 36	35 x 35			←	
			30 x 45	34 x 40	36 x 38	37 x 37			↙	

go to TABLE OF CONTENTS

# Heat Rejection Line Set

## AC2 Outdoor Unit / Ground Loop Coil

As mentioned earlier, there are two different devices requiring a refrigeration line set which can be connected for heat rejection to perform air conditioning: an accessory AC2-series outdoor unit, or a ground loop heat exchanger / water coil (with ground loop circulator). The line set is connected in the same way for both devices.

Note that no refrigeration line set is required if not using any external heat rejection method, or if rejecting heat to open loop well water.

## Line Set Interconnect Tubing

Once both the indoor and outdoor unit (or ground loop coil) have been mounted, the line set may be run between them. Both lines of the interconnecting tubing are **1/2" OD**; outgoing line is hot discharge gas from compressor, and the return line to PC unit is liquid refrigerant.

The tubing used for this procedure must be ACR refrigeration tubing (cleaned & dehydrated). Every effort must be made to insure that the tubing does not become contaminated during installation. It is recommended that caps be placed on the open ends of tubing immediately after cuts are made and that these caps are only removed after all bends have been made and the pipe fixed in its permanent location ready to make the silver soldered joints. It is very important to keep a refrigeration system perfectly clean and dry. Removing the caps just prior to silver soldering or flaring will ensure minimum exposure to humidity in the atmosphere.

Size	Line set connection nut wrench	Hex key to open/close	Valve cap wrench	Charging port cap wrench
1/2"	24 mm (1")	5 mm (3/16")	19 mm (3/4")	14 mm (9/16")

Size	Line set connection nut torque	Hex key torque	Valve cap torque	Charging port cap torque
1/2"	40-45 N.m (30-33 ft.lb)	7-9 N.m (5-7 ft.lb)	25-30 N.m (18-22 ft.lb)	10-12 N.m (7-9 ft.lb)

## Outdoor Unit Connections

The outdoor unit has capped off (soldered) pipes from the factory and is charged with 15 - 25 psig of nitrogen. Remove the side cover from the outdoor unit so that the piping is accessible.

See earlier diagram **002297PDG** for illustration of a typical installation.

## Oil Traps

If the line set has a vertical rise of over 20 ft (6 m), then an oil trap must be placed in the line set every 20 ft (6 m) of rise as shown in diagram.

## Filter-Dryer

Note that **no field installed filter-dryer is required**, since one is included in the indoor unit.

## Pipe Insulation

All line set piping between the indoor and outdoor units should be insulated with 3/8" thick closed cell pipe insulation to prevent heat transfer to or from the lines. It can be slid onto the capped tubing without having to slice it down the side for the most part. Ensure that any joints in the line sets are accessible for leak testing.

## Silver Soldering Line Sets

All joints are to be silver soldered with 5% silver solder. **It is absolutely required that dry nitrogen be bled through the system during all silver soldering procedures so that no oxidation occurs on the inside of the copper tubing.** Connect a set of refrigeration gauges to the service ports (Schrader ports) on the access valves of the indoor unit, the low side (blue hose) to the vapour line and the high side (red hose) to the liquid line. Connect the charge line (yellow hose) to a nitrogen source. Disconnect the high side (red) hose at the manifold so that nitrogen may flow freely through the line set. Adjust the nitrogen pressure through the low side (blue hose) so that it can be very lightly felt when a finger is placed on the disconnected high side (red) hose.

A wet rag may be wrapped around each of the outdoor unit ports to prevent melting the grommet when silver soldering; however this should not be necessary due to the distance from the grommet. Ensure that no water enters any of the ports or tubing.

ALL MODEL SIZES	Vapour line O.D.	1/2"
	Liquid line O.D.	1/2"



**IMPORTANT NOTE: The line set between the indoor and outdoor units must not exceed 70 ft. (21 m) in length.**

## Indoor Unit Connections

The indoor unit connections for the line set are 3-way brass service valves with flare connections. After the line set is installed, the tubing can be vacuumed through the Schrader charging port on the 3-way valve, then the valve opened to let refrigerant contained in the indoor unit into the line set and outdoor unit.

The indoor unit comes pre-charged with enough refrigerant for a 20 ft. (6.1 m) line set. Longer line sets will require added charge; see next page.

**Copper flare to solder adapters are included with the indoor unit, to remove the requirement to do an accurate flare in the field.** These are shipped along with the mounting feet for the outdoor unit near the compressor in the indoor unit.

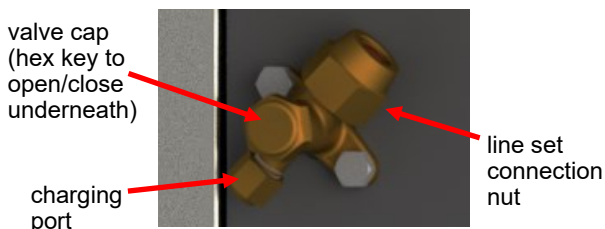

## Pressure Testing

Once all connections are complete, the system should be pressure tested to a final test pressure of **125 psig (860 kPa)** with dry nitrogen. Reconnect the high side (red) hose to the manifold and pressurize the line set. It is recommended to pressure test in stages, listening and inspecting for leaks along the way. For example, 10 psig (70 kPa), 25 psig (170kPa), 75 psig (520kPa) and then finally 125PSIG (860kPa). Check all joints at the unit and any made in the interconnect tubing for leaks using soap suds, Spray Nine, etc. It is important not to bypass this step as vacuuming the system with a leak will be impossible and attempting to do so will introduce moisture into the system, making the vacuum process take much longer than if the leak had been found and repaired first. It is recommended that the system be left under pressure for a minimum of two hours to ensure there are no small leaks that were undetected.

## Vacuuming the System

Remove the pressure from the system and connect the vacuum pump to the charge line (yellow hose) of the refrigeration manifold. Tighten all hose connections, open the valves on the manifold and start the vacuum pump.

Vacuum the system until the reading on an electronic vacuum gauge remains below 500 microns for a period of 5 minutes after the vacuum pump is shut off and the system sealed.

## Charging the System

The indoor unit is pre-charged for line sets up to 20 ft long. Once the system has been vacuumed, if extra refrigerant is required due to the length of the line set, it may be added before opening the access valves. Close off the charge valve on the refrigeration manifold set and disconnect the vacuum pump. Connect the charge (yellow) hose to the **liquid port** of a refrigerant tank and place the tank on a scale. Open the liquid valve of the refrigerant tank and then slightly loosen the charge (yellow) hose at the manifold until liquid comes out, then quickly re-tighten the hose. This will ensure that no air enters the system. Zero the scale and then add the calculated amount of refrigerant from the tables to the right.

Once the additional charge (if any) has been added, disconnect both hoses from the service ports of the access valves and place the caps back on them, tighten with a wrench.

Remove the caps from the access valves and open both valves with a hex key. Open the valves (counter-clockwise) until they stop turning. Replace the caps and tighten with a wrench.

**The system is now ready for startup. Clean up the area, install all access panels except the one which gives access to the electrical box. Proceed to the Startup Section of the manual before turning the power on to the unit.**

**TABLE 19 - Extra Charge Required**

Extra charge required for line sets >20 ft (6 m)

1.1 oz per ft	0.10 kg per m
---------------	---------------

**TABLE 20 - Extra Charge Chart**

Total Line set (ft)	Extra Charge (oz)	Extra Charge (lb)	Extra Charge (kg)
22	2	0.1	0.06
24	4	0.3	0.12
26	7	0.4	0.19
28	9	0.6	0.25
30	11	0.7	0.31
32	13	0.8	0.37
34	15	1.0	0.44
36	18	1.1	0.50
38	20	1.2	0.56
40	22	1.4	0.62
42	24	1.5	0.69
44	26	1.7	0.75
46	29	1.8	0.81
48	31	1.9	0.87
50	33	2.1	0.94
52	35	2.2	1.00
54	37	2.3	1.06
56	40	2.5	1.12
58	42	2.6	1.19
60	44	2.8	1.25
62	46	2.9	1.31
64	48	3.0	1.37
66	51	3.2	1.43
68	53	3.3	1.50
70	55	3.4	1.56
72	57	3.6	1.62
74	59	3.7	1.68



# Operation

## BACnet Control

If controlling the system via the BACnet interface, skip the entire **Operation** section. In this case, demands for dehumidification, air heating, air cooling, and pool water heating will come from the building control system. The supplied air thermostat should not be installed, and internal Setpoint Control for pool water temperature will not be active.

See the **BACnet Interface** section later in this manual for network specification and BACnet object names.

## Air Thermostat Operation

Whenever the PC unit is powered up, the thermostat will measure the room air temperature and relative humidity (RH), and alternate between the two values on the LCD interface.

1. The first SCROLL button press will display the air temperature setpoint on the LCD. Press the up or down arrow buttons to adjust the setpoint.
2. The second SCROLL button press will display the auxiliary air temperature (plenum heater) setpoint on the LCD. "HEAT" indicator will be displayed. Setpoint may be adjusted with the arrow buttons.
3. The third SCROLL button press will display the RH setpoint. "RH" indicator will be displayed. Setpoint may be adjusted with the arrow buttons.
4. The fourth SCROLL button press brings back the alternating temperature/RH display.

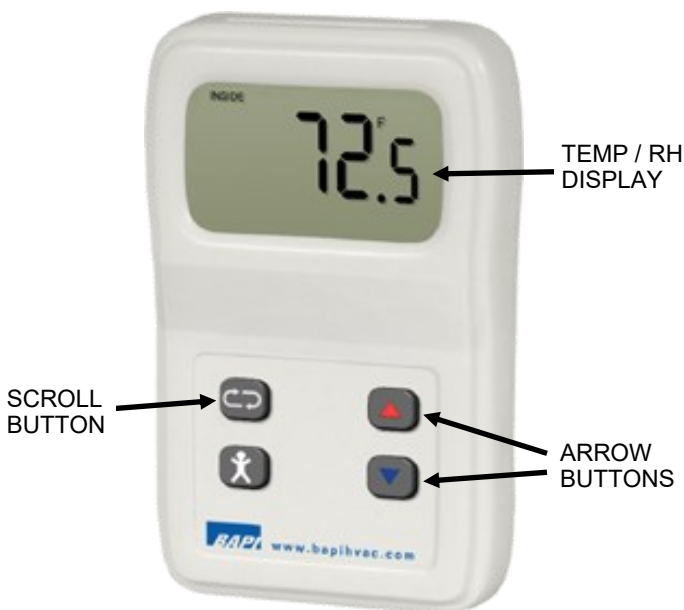

**FIGURE 3: BAPI STAT4 Air Thermostat**

**NOTE:**

If air thermostat is just displaying temperature instead of alternating temperature/RH, see the following **Air Thermostat Setup**.

## Air Thermostat Placement

The communicating air thermostat should be placed in the pool room in an accessible location, **at least 48 inches above floor level**.

This is to be sure the sensor is not subjected to chloramides, which can form closer to floor level if pool room chemistry becomes unbalanced. Chloramides can lead to rapid failure of the sensor inside the thermostat, necessitating sensor replacement. See **Repair Procedures** chapter for replacement of sensor.

## Air Thermostat Setup

The thermostat should come pre-configured from factory to operate as described. If an unconfigured thermostat is received, it should be set up as follows:

- Remove cover and set DIP switch #7 (PROG) to **ON**.
- Use the arrow buttons to advance through the list of **P** settings in the following table. Push the SCROLL button to select a **P** value to change.
- Use the arrow buttons to adjust the value, e.g. for P6 change "T" to "rHt". Push the SCROLL button to enter.
- To exit Program Mode, set DIP switch #7 back to **OFF**.

Then start the PC App and press the **CONFIGURE BAPISTAT4** button as shown on next page to write the rest of the configuration values to the thermostat.

TABLE 21 - BAPI STAT4 Settings			
Menu	Title	Default	Change to
P1	Unit Address Offset	0	
P2	Temperature Setpoint Low Limit	60°F	50°F
P3	Temperature Setpoint High Limit	80°F	90°F
P4	Humidity Setpoint Low limit	0%	30%
P5	Humidity Setpoint High Limit	100%	90%
P6	LCD Mode	T	rHt
P7	LCD Resolution	0.1 (01)	
P8	LCD Cycle Rate	5	
P9	Temperature Offset Adjustment	0.0	
P10	Humidity Offset Adjustment	0.0	
P11	Baud	57,600 (576)	192,000 (192)
P12	Stop	1	
P13	Parity	None	
P14	Firmware Version		

Note that there is a dip switch inside the thermostat to select between °C and °F:

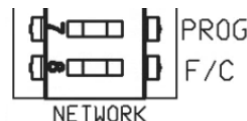

## Changing Air Setpoints Using PC App

The air setpoints can also be changed through the free PC App software, as shown below. This requires a laptop connected via USB cord to the control board; see the [PC Application \(PC App\)](#) section for more details.

Go to [View-->Pool Room Control \(MODBUS\)](#) to bring up the window below. Once settings are adjusted in PC App, be sure to press the **CONFIGURE BAPISTAT4** button to write the new values to the thermostat.

Set units (STANDARD or METRIC)

Measured room air temperature & humidity

Room humidity setpoint

Room temperature setpoint

Send window's settings to room air thermostat

Aux. heat (plenum heater) temperature setpoint

Return to default settings

The recommended Stage 1 Setpoint of **82°F** and Delta of **2°F** are shown. This is 2°F higher than the pool water setpoint, which will minimize evaporation rate from the pool, as described in the [PC Sizing](#) section. The recommended Auxiliary Setpoint is **81°F** with a Delta of **2°F**, so that the air temperature does not fall much below the pool temperature in cold weather when the plenum heater may be doing most of the air heating.

With these setpoints, air heating demand will be activated if the air temperature drops below 80°F, and will persist until the air warms up to 82°F. (Air Reheat mode, like the other modes, will only actually come on according to the demand table in the first section of this manual.) If the air temperature continues to drop to 79°F, the plenum heater will come on and stay on until the temperature rises to 81°F; plenum heater operation does not depend on the other demands or operating modes.

Also, with the setpoints shown and if presence of an AC2 outdoor unit is detected, when air temperature exceeds 84°F air cooling demand will be activated, and persist until air temperature falls to 82°F.

## Pool Water Temperature Control (PC-T only)

One of the features of the PC's GEN2 Control Board is built in aquastat functionality known as "Setpoint Control". This is an internal routine to sample the pool water temperature to determine if pool heat is required; water temperature is measured using a sensor in a well in the internal PVC piping. The pool pump is turned on at regular intervals to refresh the water temperature (if the system is set up for the PC unit to have control of the pump). If the PC unit has control of the pool pump and sampling is not desired, there is the option to use an external accessory temperature sensor.

There is also provision to connect an external aquastat or controller instead of using this routine, for example if two pools of two different temperatures are being heated.

### 1. Pool Water: Setpoint Control

It is recommended that this method be used to control the PC system's pool water heat demand since it eliminates the need for an external temperature sensor or aquastat.

There are two options for Setpoint Control, Indoor Loop (ICR) method and HTS/CTS method.

#### Setpoint Control Method 1 - Indoor Loop (ICR)

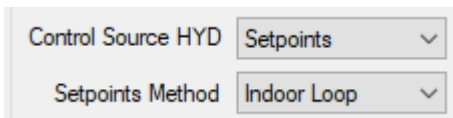

This is the default method and uses the Indoor OUT temperature probe inside the unit (actually located on the IN pipe) for control. Its value is displayed in the **Pool Water Temperature** box on the PC App's [View-->Pool Water Setpoints](#) window. If this temperature shows **NC**, then either the probe is not connected to the board or there is a problem with it.

Unless the pool pump is set up to run continuously, the PC unit will cycle the pool pump on and off when the unit is not in pool heat mode, in order to sample the water temperature. When pool heat mode ends, the pool pump will continue to run for 30 seconds. It will then cycle with an OFF time and ON time as set by the [Set ICR Sampling](#) popup which appears when **SET** is clicked on the [View-->Pool Water Setpoints](#) window. The timer counts down the time remaining before the next switch between ON/OFF. The Pool Circulator indicator will indicate when the circulator is ON, OFF or SAMPLING. The default sampling times are 2 minutes ON and 6 minutes OFF. The LCD interface will indicate when the ICR is sampling (ON) as well. The **Timer Override** button will reduce the countdown timer to 10 seconds.

See the next column, and also the [PC Application \(PC App\)](#) section for full screenshots of the various windows.

#### Setpoint Control Method 2 - External HTS/CTS

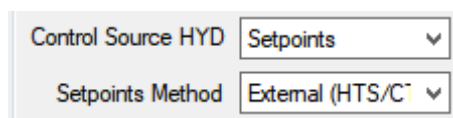

When this method is used, no pool pump control for temperature sampling will occur. It requires an external temperature sensor placed in a dry well in the pool water. Its value is displayed in the **Pool Water Temperature** box on the PC App's [View-->Pool Water Setpoints](#) screen. If this temperature shows **NC**, then either the probe is not connected to the board or there is a problem with it.

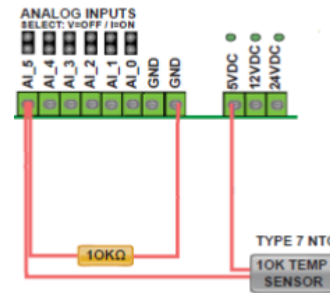

A 10K Type 7 (or Type 3) NTC thermistor along with a 10K 1% or better resistor must be connected to the control board in order to use the External HTS/CTS method. Connect the sensor to the AI\_5 input as shown above and on the wiring diagram (SCH) in the [Model Specific Information](#) section. Remove the AI\_5 jumper on the control board.

For both setpoint control methods, pool water setpoint is controlled through the LCD interface or PC App ([View-->Pool Water Setpoints](#)).

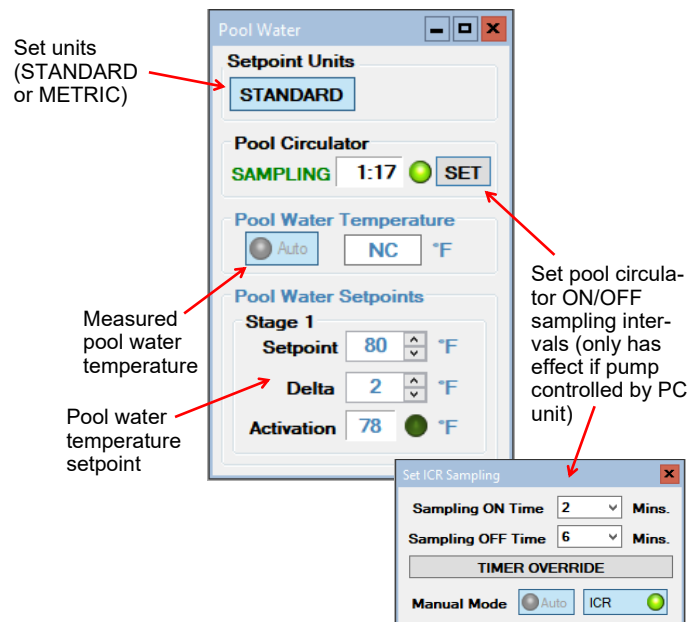

The recommended Setpoint of **80°F** and Delta of **2°F** are shown. This is 2°F less than the air setpoint, which will minimize evaporation rate from the pool, as described in the [PC Sizing](#) section.

With these setpoints, pool water heating will be called for if the pool water temperature drops below 78°F, and will persist until the pool water temperature rises to 80°F.

### 2. Pool Water: Signals Control

In this control method, pool water heat demand comes from an external device, like an aquastat, combination of aquastats, or other controller with a dry contact that relays a 24VAC signal.

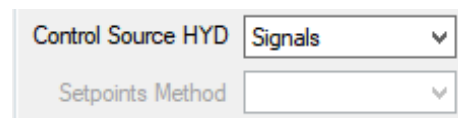

The wiring connections are at the top right of the PC's control board, on the screw terminal connector section marked **AQUASTAT**. This is shown on the wiring (SCH) diagram in the [Model Specific Information](#) section. The external device needs to send the 24VAC signal from RA back to the Y1A terminal to call for pool water heating. C is the common or ground terminal for powering the external device.

# PC Application (PC App)

**NOTE:** Before using the PC Application, refer to [Appendices](#) for installation instructions for the PC Application and USB driver for the COM port. Both must be installed in order to run the PC App and communicate with the control board.

Connect a USB cable between the PC and the control board USB connector located at the bottom center of the board. Use the Windows Start menu to launch the PC App. You should see a screen similar to the one below. The revision of the PC APP is shown in the top left corner of the screen. Click the **Connect** button to begin communications with the control board.

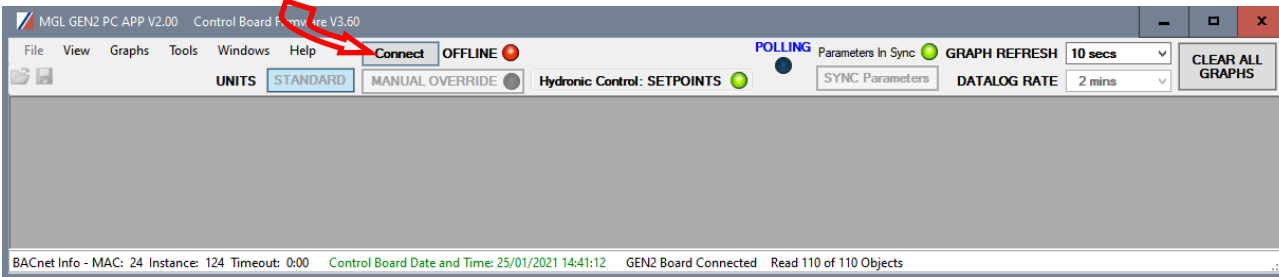

Once connected, the menus and buttons will become accessible, the number of Objects available and Read should appear (they should be the same) and the Polling LED will begin to flash. The PC time and date will appear at the bottom left corner of the screen. Clicking on “Control Board Date and Time” will display the current control board date and time. If the date and time need to be adjusted, click on menu **Tools—>Set Date and Time**. The control board date and time will be set to that of the PC.

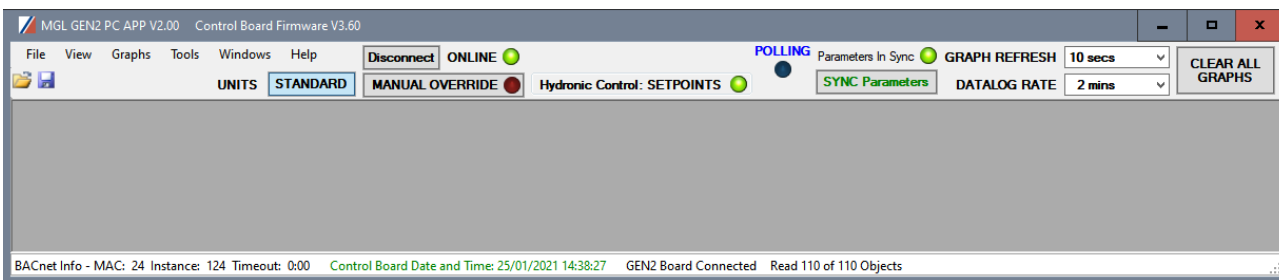

## PC Application Menus

The following pages describe the PC APP’s menus in detail. There are six menus: **File, View, Graphs, Tools, Windows, Help**.

**File Menu:** This menu handles page arrangements. If one or multiple pages are open and arranged as desired for viewing, this page arrangement may be saved and re-used the next time the PC APP is used.

- File-->Open:** Opens a saved page arrangement.
- File-->Save:** Saves the current page arrangement.
- File-->Exit:** Exits the PC Application.

**Windows Menu:** This menu is used to arrange windows (pages), or to bring a particular window to the front.

- Windows-->Cascade:** Arranges windows one in front of the other each with a small right and down offset from the last.
- Windows-->Tile Vertical:** Arranges windows side by side, stretching them fully from top to bottom.
- Windows-->Tile Horizontal:** Arranges windows up and down, stretching them fully from left to right
- Windows-->Close All:** Closes all open windows.

**Help Menu:** This shows information about the PC Application.

- Help-->About:** Displays the window shown to the right.

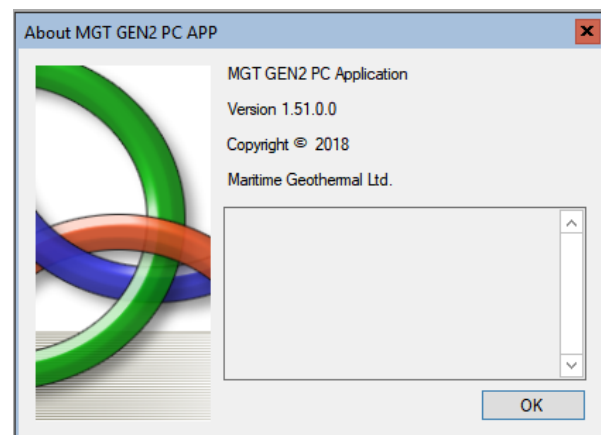

**View Menu:**

This menu handles all of the operational viewing screens. Clicking on the View submenus will open the page in the PC APP's frame.

**View-->Control Panel:** The main control panel window will open, shown below.

Equipment model information. → PC Series - Size 65 Refrigerant: R410a

Operational status of the system. → SYSTEM MODE Off

Manual controls are enabled when in **MANUAL OVERRIDE** mode. → Manual Demand

Indicators show the demand from the control system. → Y1, DH, O, G, W2

Compressor information: refer to **Stage Statistics** window shown later. → STAGE1

Auxiliary heat information, air. Status lights indicates when in use. → Air Auxiliary

Refrigeration system pressure data, along with alarm indicators. → Refrigerant Pressures

Refrigeration system temperature data. → Refrigerant Temperatures

Indoor EEV. Status light indicates when in use. → EEV1 Position

Solenoid valve NC1. Status light indicates when energized. See circuit diagrams (RCD's) in this manual for usage. → Solenoid Valve#1

Clicking the **SERVICE** button will disable the unit and fully open EEV and solenoid valve to allow repair work to be done to the refrigeration system. → SERVICE

Indoor fan information. Click **SET** to adjust airflow (Same as **View-->Indoor Fan**). → Indoor Fan

**Rejection Select** selects whether air or pool water will receive heat if there is a call for dehumidification, both air and pool temperature are satisfied, and there is no outdoor unit connected for heat rejection. If outdoor unit is detected, will read **"Outdoor Unit"**. → Rejection Sel

Short Cycle timer and override button for when unit is being serviced. → SC Timer

4-way (reversing) valves RV1 & RV2. Status light indicates when energized. See circuit diagrams (RCD's) in this manual for usage. → Reversing Valve#2 (TOP), Reversing Valve#1 (BOT)

**View-->Pool Room Control (MODBUS):** Air temperature & humidity measurements & setpoints, from the air thermostat.

**View-->Pool Water Setpoints:** Pool water temperature and setpoint, for internal Setpoint Control routine.

Room temperature setpoint → Room Temperature Setpoint

Aux. heat (plenum heater) temperature setpoint → Auxiliary Setpoint

Set units (STANDARD or METRIC) → Setpoint Units

Measured room air temperature & humidity → Room Temperature, Room RH

Room humidity setpoint → Room RH Setpoint

Measured pool water temperature → Pool Water Temperature

Pool water temperature setpoint → Pool Water Setpoints

Set pool circulator ON/OFF sampling intervals (only if pump controlled by PC unit) → Pool Circulator

Send window's settings to air thermostat → CONFIGURE BAPISTAT4

Return to default settings → SET ROOM DEFAULTS

Set ICR Sampling → Set ICR Sampling

**View-->Alarms, Limits and Faults**

The alarms page has four tabs:

1. **ALARMS** - Current alarm status, alarm count, high and low refrigeration alarm cutout values, and short cycle timer.
2. **ALARMS LIST** - List of alarms that have occurred since the PC APP has been operating (this will be lost when the PC is disconnected from the control board.)
3. **LIMITS** - Limits in effect which prevent compressor operation but that do not cause an alarm.
4. **FAULTS** - List of board hardware faults.

**View-->Alarms, Limits and Faults (ALARMS Tab):**

**NOTE: Greyed out Alarms in the PC APP are not applicable to the system setup and are not monitored by the control board.**  
**NOTE: Refer to Alarms and Faults screenshot below to see which alarms have a count.**

- Alarms without a count:** These alarms only occur one time at which point they immediately create a **Permanent Alarm**.
- Alarms with a count:** When an alarm occurs the compressor will stop, the alarm count will increase and the **Short Cycle Timer** will start. When the **SC Timer** expires the compressor will re-start. If no further alarms occur within **Count Reduce Time**, the alarm count will be reduced by 1. If another alarm occurs within **Count Reduce Time** (see [Configuration Page](#)) the count will increase by 1. If alarms continue to occur, when the alarm count reaches the **Maximum Count** value a **Permanent Alarm** will occur.
- Master Alarm:** This alarm occurs when any permanent alarm occurs. It is used to simply indicate that there is an alarm.
- Permanent Alarm:** The compressor will be locked out until the **Permanent Alarm** is manually reset either by cycling the power or clicking on the **RESET** button
- Low Pressure:** A low pressure alarm occurs when the suction pressure drops to or below the **Low Pressure Cutout** value. The low pressure is checked just before a compressor start; if it is OK the compressor will start, otherwise an alarm will occur. When the compressor starts, low pressure alarm will be ignored for the number of seconds that **Low Pressure Ignore** is set to, after which the low pressure alarm will be re-enabled. This allows a dip in suction pressure below the cutout point during startup without causing a nuisance alarm.
- High Pressure:** A high pressure alarm occurs when the discharge pressure rises to or above the **High Pressure Cutout Value**.
- Compressor Monitor:** This alarm occurs when compressor protection module sends a fault signal to control board, generally due to compressor windings overheating. (PC models do not have compressor protection modules.)
- Compressor Status:** This alarm occurs when there is current draw on the compressor but no call for the compressor to be on (i.e. welded contactor) or when there is call for the compressor to be on but there is no compressor current draw (i.e. manual high pressure control is open or contactor failure). Requires current sensor accessory.
- Phase Monitor:** This alarm occurs when the Phase Monitor detects a fault condition and sends a fault signal to the control board. For three phase units only and requires Phase Monitor accessory.
- Low Charge / EEV:** This alarm occurs if the EEV has been at >99% for 20 minutes within first hour of a cycle.
- Loss of Charge (LOC):** This alarm occurs if both the low pressure and high pressure sensors are below 30 psig (207kPa).
- Condensate Drain:** Condensate overflow sensor has detected overflow (only if equipped with sensor).

Go the Alarms Troubleshooting section of the **Troubleshooting** section of the manual to address alarm issues.

The screenshot shows the 'Alarms, Limits and Faults' window with four tabs: ALARMS, ALARMS LIST, LIMITS, and FAULTS. The 'ALARMS' tab is active, showing a table of alarm statuses. A 'RESET' button is located at the top left. A 'MASTER ALARM' indicator is shown as a red light. The table lists various alarms with their counts and whether they are permanent. Cutout values for Low Pressure (75 PSIG) and High Pressure (565 PSIG) are shown. A 'Short Cycle Timer' is set to 0:00. A 'SC Override' button is at the bottom right. A 'Flow/Water Valve Alarms' section is at the bottom.

**Annotations:**

- RESET:** This button will erase all alarms and alarm counters, including a permanent alarm.
- WARNING:** Repeated resets can freeze and rupture heat exchangers, ruining the unit and voiding the warranty. The source of the alarm should be determined before resetting the unit if possible or during operation after a reset.
- MASTER ALARM:** Master Alarm occurs when any alarm occurs.
- CUTOUT:** Low Pressure cut out. High Pressure cut out.
- Greyed out alarms:** Greyed out alarms are not applicable to the system.
- SC Timer:** Short Cycle Timer counts down time until the next compressor start is allowed.
- SC Override:** This button will reduce the short cycle timer value to 10 seconds.

**View-->Alarms, Limits and Faults (ALARMS LIST Tab):**

This tab show a history of alarms that have occurred since the PC APP was connected to the control board. This list will be lost when the PC APP is disconnected.

Each alarm that occurs while the PC APP is connected to the control board will appear here. The alarm type and a time stamp will be shown. The alarms list will be erased when the PC APP is disconnected from the control board.

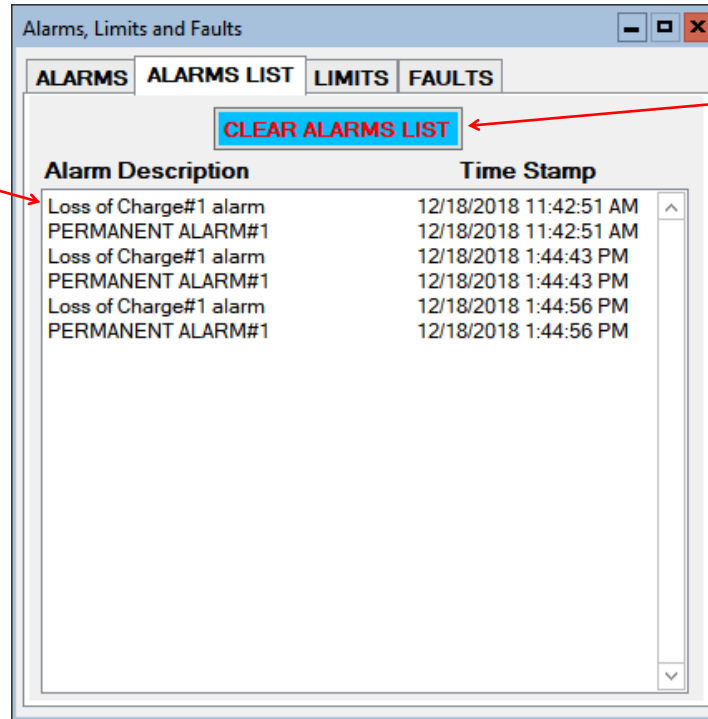

This button will erase the alarm events in the Alarm List.

**View-->Alarms, Limits and Faults (LIMITS Tab):**

This tab shows temperatures that are out of limits but have not caused an alarm. These limits are shown on the [Tools-->Configuration](#) page.

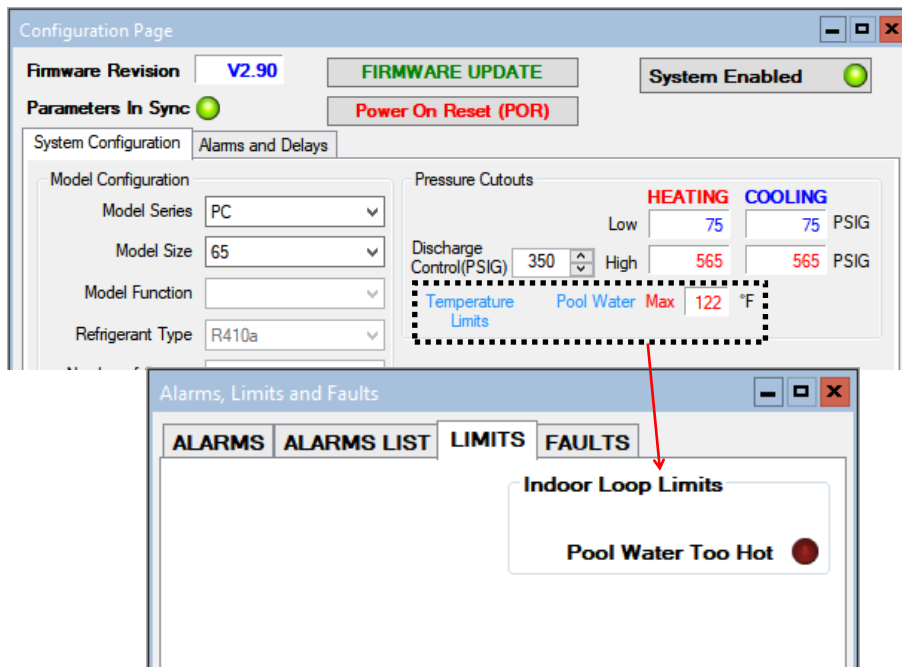

**View-->Alarms, Limits and Faults (FAULTS tab):**

This tab shows hardware faults that could occur. If one of these faults occurs there may be a problem with the control board hardware, with LCD Display and buttons, or with a sensor.

**If a fault occurs, some things to try:**

- Turn the power to the unit off for 20 seconds and then back on again.
- Use the menu item **Tools-->Reset to Factory Defaults**. If this clears the fault then the system configuration will have to be set up again.
- For LCD Display or Menu Button faults, turn off the power, disconnect and reconnect the cable between the LCD display board and the control board, then turn the power back on again.

**If the fault persists then there is most likely a hardware problem, and the sensor, control board, or LCD display board will need to be replaced.**

**IMPORTANT NOTE:** If the Indoor OUT (I\_OUT) probe is faulty or disconnected, pool heating will not operate if using Setpoint Control. It will continue to operate under Signals or BACnet control.

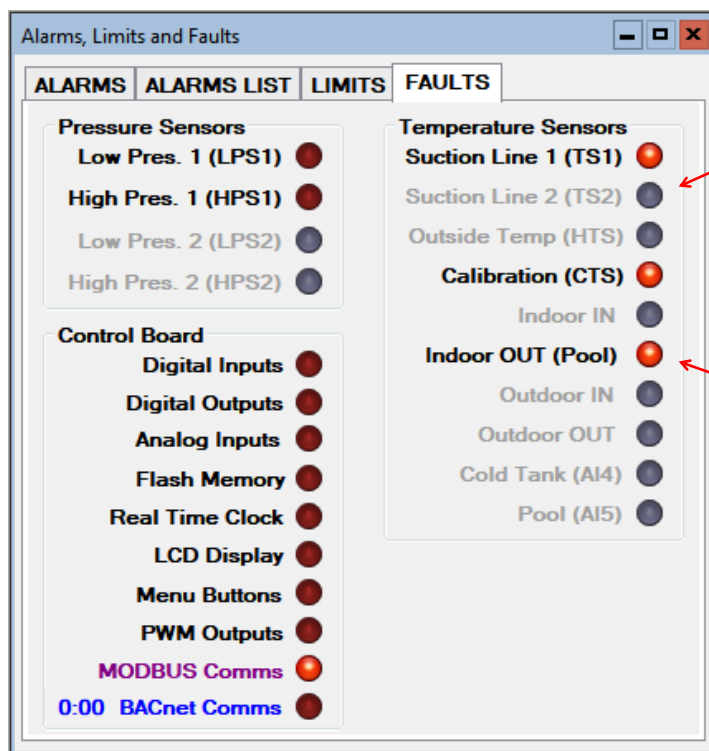

Greyed out do not apply.

Fault Indicators

**NOTE:** water temperature sensor is located on the pool water **IN** water line, but may show as **OUT** in PC App and LCD Interface.

**View-->Stage Stats:**

The compressor information: number of starts, run hours and starts per hour.

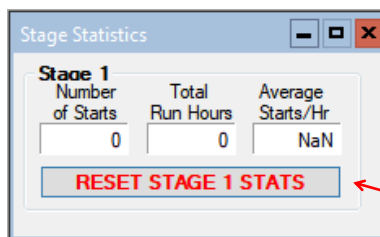

Erase the compressor statistics (only for if a compressor should need to be replaced).

**View-->Set Auxiliary Delays:**

Sets the delay before auxiliary air heat (plenum heater) is engaged on a stage 1 (compressor) demand.

**Set to "0" for no auxiliary heat engaged on a compressor-only demand from control system.**

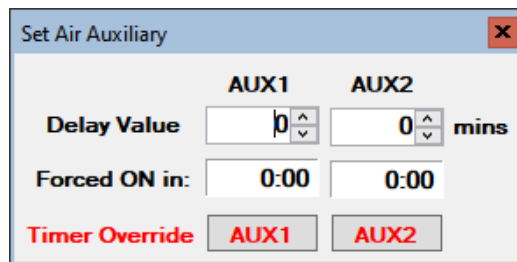



### View-->Indoor Fan

Shows the settings screen for the indoor fan/blower. Airflow may be adjusted up or down by the user within the allowed range. See **Indoor Airflow Data** section in the **Model Specific Information** chapter for airflow ranges.

NOTE: This screen may also be accessed from the **SET** button of the **Indoor Fan** section of the **Control Panel** screen.

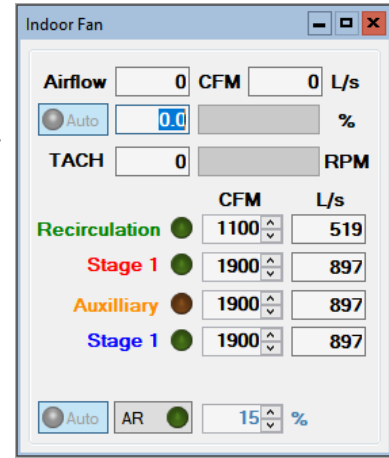

### View-->Digital Inputs

Shows the digital inputs and their individual status (ON/OFF). They may be individually controlled when in Manual Override Mode in order to facilitate troubleshooting.

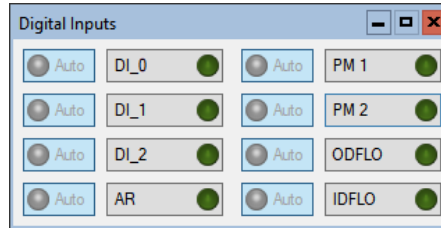

### View-->Digital Outputs

Shows the digital outputs and their individual status (ON/OFF). They may be individually controlled when in Manual Override Mode in order to facilitate troubleshooting.

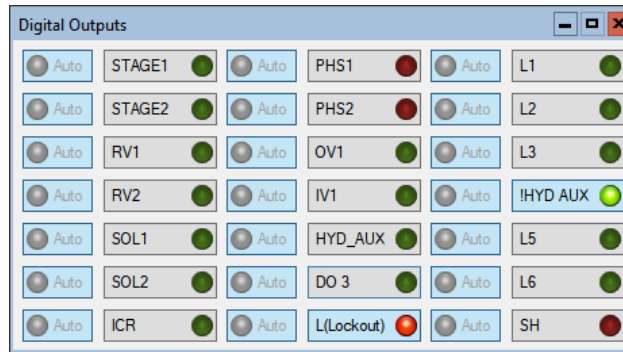

### View-->Analog Inputs

Shows the Analog inputs and their individual settings and values.

Click on the **EDIT** button to modify the blue boxes (button will now say **SAVE**). For each channel a name may be selected (up to 16 characters), and the multiplier and Offset values may be set to accommodate the connected sensor scaling. Signals may be 4-20mA (channel jumper on board ON) or 0-10VDC (channel jumper on board OFF). A variety of units are also available for selection of common measurement types. Click on **SAVE** to save the changes. Values are kept even when power is removed from the unit.

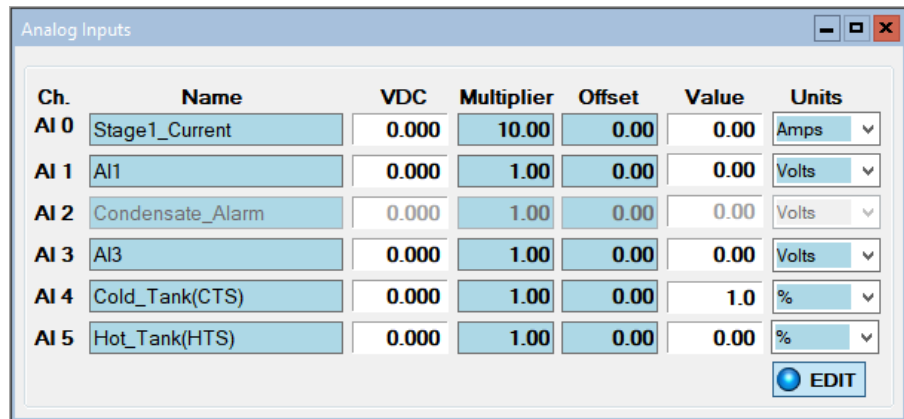

### View-->PWM Channels

Shows the PWM channels and their individual status (0-100%). They may be individually controlled when in Manual Override Mode in order to facilitate troubleshooting.

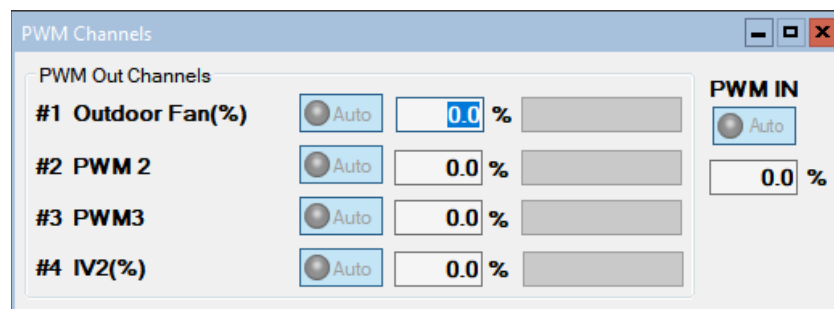

## Graphs Menu:

This menu is a list of the available graphs. Graphs are real-time and show a time stamp of when the recording started as well as a current time which will show up if the graph is screen captured. Each graph has a CLEAR button which will erase the stored data and restart the graph. There is also a master CLEAR ALL GRAPHS button at the top right of the PC APP; this will clear all open graphs and re-start them all simultaneously to keep them in sync with each other. The refresh rate for the graphs is also located at the top right of the PC APP.

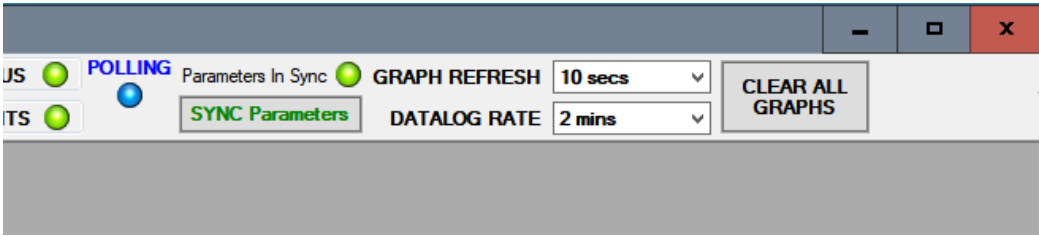

**TIP:** To screen print a graph and save it as a picture, hold down the Windows key and press Print Screen on the keyboard. The image on the screen will be saved to the folder C:\Users\Username\Pictures\Screenshots.

Graphs	Tools	Windows	Help	Disconnect	ONLINE
Control Signals Graph					
Operation Mode Graph					
Input Signals Graph					
Output Signals Graph					
EEV Position / Superheat Graph					
Vapor Line Temperature Graph					
Refrigeration Pressure and Temperature Graphs					
Indoor Fan Graph					
Pool Room Temperature/Humidity Graph					
Pool Water Temperature / Discharge Pressure Graph					
Analog Input Graphs					
PWM Channels Graph					
BACnet Timeout Graph					

- ON/OFF status of the system control signals (demands)
- ON/OFF status of operation modes
- ON/OFF status of OD DETECT and EN/DIS
- ON/OFF status of digital outputs.
- EEV position and resulting superheat
- Suction temperature
- Suction and discharge pressures & temperatures
- Indoor blower speed in % and rpm
- Air temperature & humidity as sensed by thermostat.
- Pool water temp. & compressor disch. pressure (useful for setting flow)
- All analog input channels (0-10VDC or 4-20mA)
- All PWM / 0-10VDC output channels and one PWM / 0-10VDC input channel
- For troubleshooting synchronization with 3rd party BACnet controllers

**An example of a typical graph screen.** Items that are checked will be plotted, unchecked items will not. The graph screens show the time the graph started as well as the current time to time stamp the graph when screen printed.

- Graph Name
- CLEAR button erases all graph data
- Check boxes to select which items are graphed
- Current values
- Primary Y axis on the left, secondary Y axis on the right.

X axis = Number of samples.  
 Elapsed time =  
 Number of Samples x Refresh Rate.  
 e.g. 20 samples x 1 second refresh = elapsed time of 20 seconds.

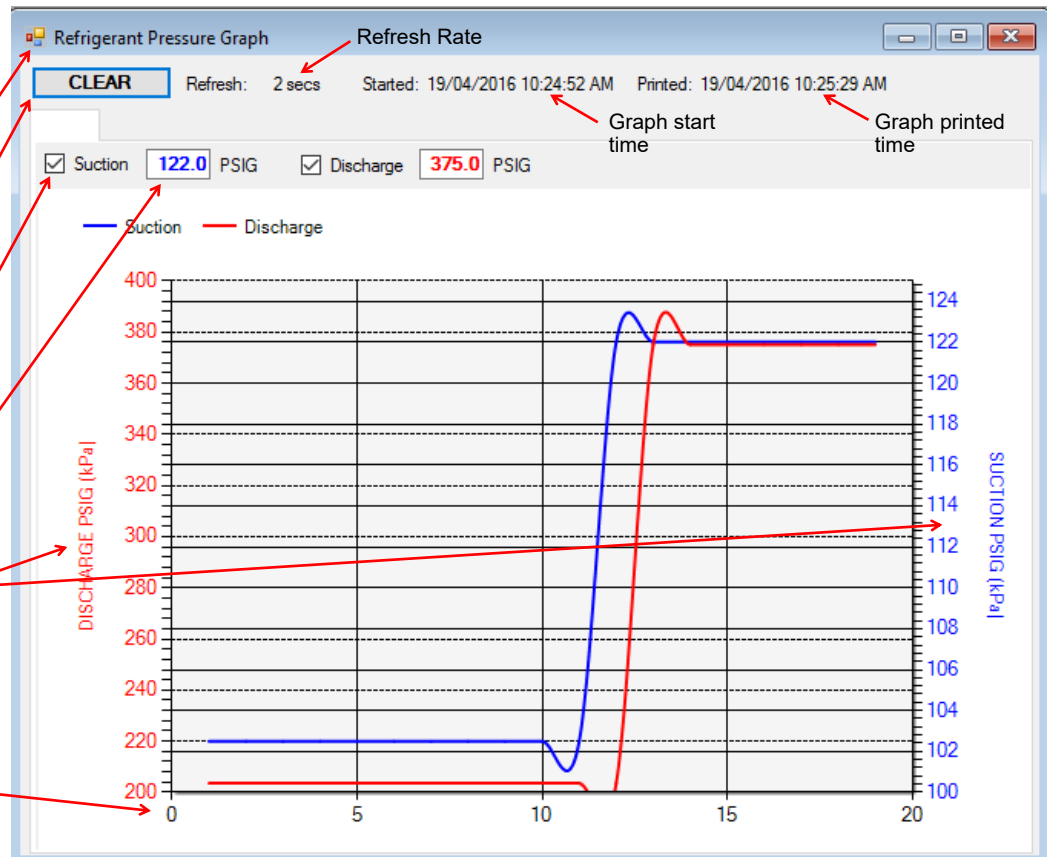

## Tools Menu:

This is where various tools for system setup and monitoring are located.

### Tools-->Configuration (System Configuration tab):

This is where the system setup is done. **Settings should only be changed by a person who has a good understanding of system operation.** Improper settings could cause the system to operate poorly or not at all.

**Configuration Page**

Firmware Revision: **V3.77** UPDATE FIRMWARE System Enabled ●

Parameters In Sync ● Power On Reset (POR)

System Configuration | Alarms and Delays

**Model Configuration**

Model Series: PC  
 Model Size: 65  
 Model Function:   
 Refrigerant Type: R410a  
 Number of Stages: 1  
 EEV Step Range: 2500 (SER)

**Pressure Cutouts**

	HEATING	COOLING	
Low	75	75	PSIG
High	565	565	PSIG

Discharge Control (PSIG): 350  
 Temperature Limits: Pool Water Max 122 °F

**Jumper Configuration**

Control Source AIR: MODBUS  
 Control Source HYD: Setpoints  
 Setpoints Method: Indoor Loop (ICR)  
 Air / Hydronic Priority:   
 Number of Tanks:   
 Heat Pump / Chiller:   
 Outdoor Ambient:   
 Summer Setback:   
 HYD AUX in Defrost:   
 OD Fan Reduction:   
 PC Rejection Mode: Room

**Alarm and Fault Controls**

	Enabled	Enabled
Outdoor Flow	●	Indoor Flow ●
Outdoor IN Temp	●	Indoor IN Temp ●
Outdoor OUT Temp	●	Indoor OUT Temp ●

Stage 1  
 Phase Monitor 1: ●  
 Compressor Status 1: ●  
 Compressor Monitor 1: ●

**BACnet Configuration**

Baudrate	MAC Address	Instance#	Max Info Frames
76800	125	980000	8

**IMPORTANT: Cycle power to invoke changes.**

**Annotations:**

- Model Configuration is used to select the system type.
- Green when parameters have been updated, red during the update.
- Firmware Revision can also be seen on the LCD Interface during power up.
- Firmware update: see Appendix
- POR: reset control system as would be done by cycling power
- Enable/Disable the compressor. Units are shipped as Disabled to prevent an unintentional compressor startup.
- Low pressure cutout is determined by pool water as loop fluid for this series.
- High pressure cutout is determined by refrigerant type.
- Pool water temperature above which compressor will be disabled; determined by pool water as loop fluid for this series.
- Control Source AIR selects how the air side of the system will be controlled. For the PC Series, this is always MODBUS (which is the BAPI Stat4 thermostat) or BACnet.
- Control Source HYD selects how the pool water side of the system will be controlled. 'Setpoints' will normally be selected, which is the internal temperature sampling routine. Other options are Signals (external aquastat) or BACnet.
- The Enabled Indicators show which alarms are enabled and which are disabled.
- If an alarm is standard or not available, the Enable button will be greyed out. If an alarm is optional (may require accessory items) the Enable button will be accessible; click on it to enable the alarm.
- Click to enable accessory flow switch.
- PC Rejection Mode selects whether air or pool water will receive heat if neither require it. If outdoor unit is auto-detected, will be greyed out. Setting is also available in [View-->Control Panel](#) window.
- Outdoor fan reduction: outdoor fan speed can be reduced if fan noise is a concern. Will be greyed out if outdoor unit is not auto-detected.
- Setpoints Method selects whether the method used will be sampling (Indoor Loop) or external pool water temperature probe (External HTS/CTS).
- If either Control Source is set to BACnet, set communication parameters. Disconnect PC App and cycle unit power to register changes to BACnet parameters.

**Tools-->Configuration (Alarms and Delays tab):**

Click on the UP/DOWN arrows to change the value, noting that values have both a low and high limit.

- The number of minutes before the unit can start again after various alarm shutdowns
- The number of minutes before the unit can start again after a normal shutdown
- Maximum Count** is the number of alarms allowed before a permanent lockout occurs.
- Count Reduce Time** is the number of hours after which the alarm count is reduced by 1 if no other alarm occurred within the timeframe.
- The minimum off time when switching between heating and cooling cycles: **can be set from 0 (switch on the fly) to 60 minutes**
- Ignore On Start** is the number of seconds an alarm will not be monitored after a compressor start occurs.

The screenshot shows the 'Alarms and Delays' configuration page. At the top, it displays 'Firmware Revision V3.60', 'UPDATE FIRMWARE' button, 'System Enabled' status, and 'Power On Reset (POR)' button. The 'Alarms and Delays' section is divided into several categories:

- Short Cycle:** 6 Mins
- Heat/Cool:** 5 Mins
- Low Pressure:**
  - Heating: 10 Mins
  - Cooling: 10 Mins
  - Maximum Count: 3
  - Count Reduce Time: 3 Hours
  - Ignore on Start: 90 Secs
- High Pressure:**
  - Heating: 10 Mins
  - Cooling: 10 Mins
  - Maximum Count: 3
  - Count Reduce Time: 3 Hours
- Outdoor Flow:** 10 Mins, 1, 2 Hours
- Indoor Flow:** 10 Mins, 1, 2 Hours
- Phase Monitor:** 10 Mins, 1, 2 Hours
- Compressor Monitor:** 30 Mins, 1, 2 Hours
- Compressor Status:** 10 Mins, 1, 2 Hours

A 'WV Override' button is located on the right side of the configuration area.

Items that do not apply to the model are greyed out.

**Tools-->Calibration:**

Generally there is no need for calibration.

The suction and discharge pressures may be calibrated in increments of 1 psi if there is a discrepancy in the readings when compared to a known good reference.

Temperature sensors may be adjusted in increments of 0.1°F. There is an **AUTO CALIBRATION** routine in the program that continually calibrates the temperatures sensors against an on board reference resistor by applying an offset to the temperature sensors. Calibration adjustments made here are in addition to the Auto Calibration routine.

**Tools-->Set Date and Time:**

This will synchronize the date and time of the control board with the computer's date and time, and will be necessary for new units or units that have been powered off for several days or more.

The date and time of both the computer and the control board are shown in the status bar at the bottom of the PC App.

**Tools-->Reset to Factory Defaults:**

This will reset all parameters to default values.

**THE SYSTEM MUST BE RECONFIGURED AFTER A RESET IS PERFORMED.**

A reset will default the system to a two stage ATW Series Size 65 with Signals as the control source. Calibrations, alarm delays, analog configurations, compressor statistics, and Setpoint Control values will be returned to defaults as well.

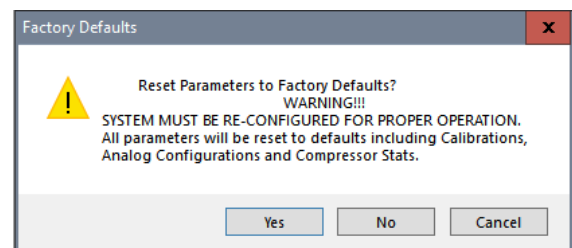

**Tools-->Update Firmware:**

Puts control board into Bootloader mode in preparation for firmware update. See Appendix.

(Also available as a button in **Tools-->Configuration** window.)

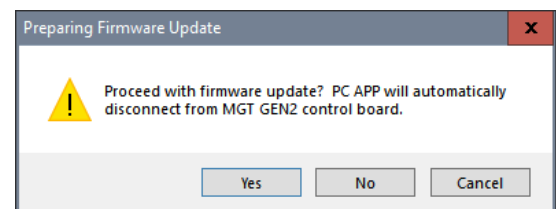

**Tools-->Power On Reset (POR):**

Resets control board as would be done by cycling power.

(Also available as a button in **Tools-->Configuration** window.)

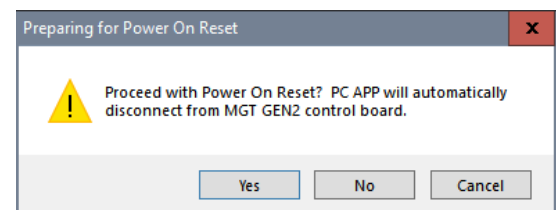

**Tools-->Datalogging (Datalog tab):**

A log will be automatically recorded at the following rates:

- SYSTEM DISABLED: every 10 minutes
- SYSTEM ENABLED: logging frequency set via the dropdown box at the top right of the PC App main window
- ALARM: logging frequency automatically set to 10 seconds, for 2 hours
- PERMANENT ALARM: every 10 minutes

The maximum number of datalog records is 32,224, which will take 45 days to fill up at the default recording rate of 2 minutes.

Note that loading datalogs is time-consuming. It is suggested to leave the **# of LOGS** at **25** until it is shown that the start date selected is suitable.

Loads the **# of LOGS** beginning from the earliest date

Loads the **# of LOGS** beginning from the selected date.

Erases the screen only

Exports the data to a file.

Erases all logged data in the control board and resets the log count to 0.

Clicking anywhere on a row will update all LEDs to show the status at the time of that log record.

**Tools-->Datalogging (Enable/Disable tab):**

Click on the checkboxes to customize which columns are shown/hidden in the datalog table.

**Board Faults**

- DI - Digital Inputs
- DO - Digital Outputs
- PWM - PWM Outputs
- A/D - A/D Converter
- RTC - Real Time Clock
- FM - EEPROM
- MN - Menu Buttons
- LCD - LCD Display
- MB - MODBUS Comms

**Temp Sensor Faults**

- TS1 - Vapour Line1
- TS2 - Vapour Line2
- ODA - Outdoor Ambient
- CAL - Calibration
- L\_IN - Indoor IN
- L\_OUT - Indoor OUT
- O\_IN - Outdoor IN
- O\_OUT - Outdoor OUT
- HTS - Hot Tank (AI5)
- CTS - Cold Tank (AI4)

**Pressure Sensor Faults**

- LPS1 - Low Pressure 1
- HPS1 - High Pressure 1
- LPS2 - Low Pressure 2
- HPS2 - High Pressure 2

**Temp Sensors**

- Outdoor Ambient
- L\_IN
- L\_OUT
- O\_IN
- O\_OUT

**Analog IN Group**

- ALL ANALOG
- Analog IN CH0
- Analog IN CH1
- Analog IN CH2
- Analog IN CH3
- Analog IN CH4
- Analog IN CH5

**PWM Group**

- ALL PWM
- PWM1
- PWM2
- OV2(%)
- IV2(%)
- PWM IN

**MODBUS Group**

- ALL MODBUS
- MODBUS Data 1
- MODBUS Data 2
- MODBUS Data 3
- MODBUS Data 4
- MODBUS Data 5

**Tools-->MODBUS:**

For future use.

**Tools-->Objects:**

This is a window to display the runtime data, which is not stored when the power is turned off. No changes are possible.

Number	Name	Type	Present Value	Setpoint	Status Bits	Out of Service	ALARM	FAULT
46	ESX_TS2	Analog Input	0.0	0	0	False	False	False
47	ESX_TS3	Analog Input	0.0	0	0	False	False	False
48	ESX_TS4	Analog Input	0.0	0	0	False	False	False
49	ESX_TS5	Analog Input	0.0	0	0	False	False	False
50	ESX_TS6	Analog Input	0.0	0	0	False	False	False
51	LPS1	Analog Input	0.0	0	0	False	False	False
52	HPS1	Analog Input	0.0	0	0	False	False	False
53	LPS2	Analog Input	0.0	0	0	False	False	False
54	HPS2	Analog Input	0.0	0	0	False	False	False
55	INDOOR_FAN_TAC	Analog Input	0.0	0	0	False	False	False
56	AI0	Analog Input	0.0	0	0	False	False	False
57	AI1	Analog Input	0.0	0	0	False	False	False

**Tools-->Parameters:**

**WARNING! The Parameters page is for advanced use only. Changing parameter values can cause the system to stop functioning properly.**

The parameters page shows all configurable memory spaces with their name and current value and allows them to be edited directly. To change a parameter value type in the new value and press ENTER.

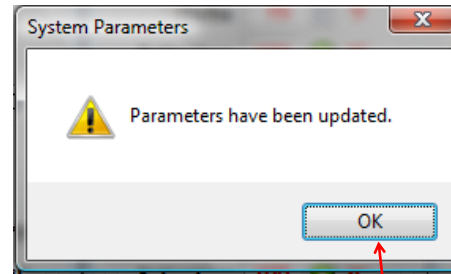
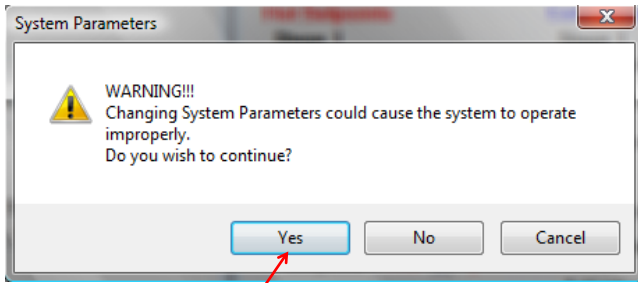

Parameters

SYNC Parameters

Name	Value
MODEL SERIES	9
MODEL SIZE	9
MODEL FUNCTION	3
REFRIGERANT_TYPE	0
HEATING_SUPERHEAT_SETPOINT	8
COOLING_SUPERHEAT_SETPOINT	8
JUMPERS	7169
JUMPERS2	64
ALARM_MASKS	4
TS_FAULT_MASKS	249
CONTROL SOURCE AIR	1

Clicking on menu item **Tools-->Parameters** will display this warning. Click on **YES** to open the parameters page.

Click this button to reload the table with the values from the control board memory.

Type in the new value and press **ENTER**, the confirmation popup will appear, click on **OK**.

**Tools-->SYSTEM TIMERS:**

This page shows all internal timers by name along with their current values.

**Tools-->Jumpers:**

This page shows internal jumper configurations, for developers.

System Timers

Name	Value	Time Value
Stage 1 Short Cycle Timer	0	0:00:00
Stage 2 Short Cycle Timer	0	0:00:00
Stage 1 Runtime	0	0:00:00
Stage 2 Runtime	0	0:00:00
Stage 2 Timed ON in:	0	0:00:00
Air Auxiliary S1 Timed ON in:	0	0:00:00
Air Auxiliary S2 Timed ON in:	0	0:00:00
Hydronic Auxiliary Timed ON in:	0	0:00:00
Indoor Loop Circulator Sampling	0	0:00:00
Outdoor Reset Hold	0	0:00:00
Wait to Defrost	0	0:00:00
Defrost Timer	0	0:00:00
Defrost Hold Previous Values (Temp Rise)	0	0:00:00
Defrost Switch Delay	0	0:00:00
Stage 1 Low Pressure Ignore	0	0:00:00
Stage 2 Low Pressure Ignore	0	0:00:00

Jumper Configurations

**JUMPERS 7169**

Unused Y2 Disabled in Cooling Heat(0) / Cool(1) Priority Stages - One(0) / Two(1)	Summer Setback Enabled PC Rejection - Room(0) / Pool(1) Units Heater(0) / Chiller(1)	Outdoor Setpoint
0 0 0 1 15 12	1 1 0 0 11 8	0 0 0 7

**JUMPERS 2 64**

Unused Spare Cold Tank Enabled Hot Tank Enabled	S1 Top Up Enabled System Enabled (ICR/HYD AUX) Stage2 Enabled Stage1 Enabled	HYD A MO f
0 0 0 0 15 12	0 0 0 0 11 8	0 1 0 7

**Tools-->System Enable/Disable:**

Enable/Disable the compressor. Units are shipped as Disabled to prevent an unintentional compressor startup. (Also available as a button in **Tools-->Configuration** window.)

# LCD Interface & Menu

These are examples of the unit status and operating data displayed when at the message display level (top level). Pressing ENTER will enter into the menu levels beginning with the Main Menu.

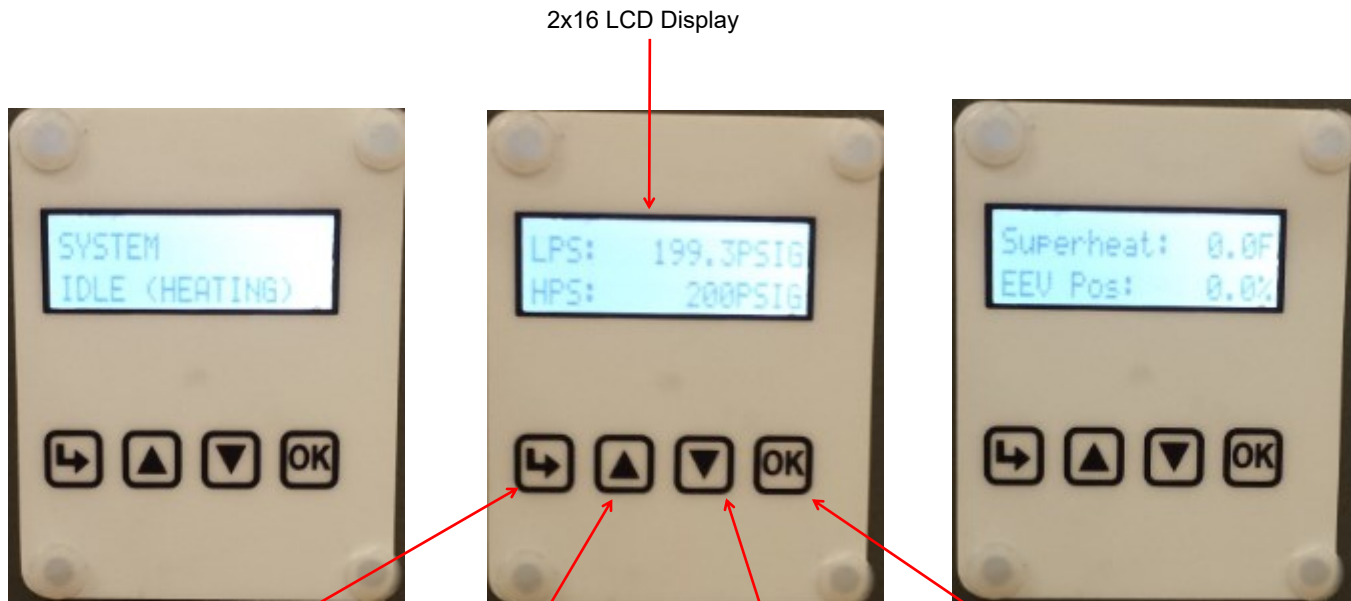

**ENTER** button:  
Use this to push down to the next menu level. Also saves value if at parameter menu level.

**UP** button:  
Use this to scroll up through the items available at a menu level.

**DOWN** button:  
Use this to scroll down through the items available at a menu level.

**OK/EXIT** button:  
Use this to come back up one menu level. Also saves value if at parameter menu level.





**Main Menu:** This is a list of the various tools are used for system setup and monitoring.  
The table shows what is displayed based on each press of the ENTER button starting at the Main Menu level.

<b>ENTER (From Main)</b>	<b>ENTER (First Press)</b>	<b>ENTER (Second Press)</b>	<b>ENTER (Third Press)</b>	<b>Description</b>
<b>Setpoint Control</b> <i>(PC-T using Setpoint control only)</i>	— <b>Setpoints</b>	— <b>Pool Water</b>	— <b>Stage 1 Setpoint</b>	Pool water heat demand stops when water temperature rises to this point.
			— <b>Stage 1 Delta</b>	Pool water heat demand starts when water temp. drops below setpoint by this amount.
		— <b>Room Deltas</b>	— <b>Room Temp Delta</b>	Air reheat demand starts when air temperature drops below setpoint by this amount.
			— <b>Room Aux Delta</b>	Air auxiliary heat demand starts when air temp. drops below setpoint by this amount.
			— <b>Room RH Delta</b>	Dehumidification demand starts when RH rises above setpoint by this amount.
<b>System EN/DIS</b>	— <b>Enable System?</b>	— <b>Disable</b>		Disable compressor and auxiliary.
		— <b>Enable</b>		Enable compressor and auxiliary.
<b>Service Mode</b>	— <b>Service Mode?</b>	— <b>NO</b>		Do not enter Service Mode.
		— <b>YES</b>		Enter into Service Mode.
<b>EEV Control</b>	— <b>EEV1</b>	— <b>Auto/Manual</b>	— <b>Auto</b>	Puts EEV in Auto mode.
			— <b>Manual</b>	Puts EEV in Manual mode.
		— <b>Manual Position</b>	— <b>EEV Position (%)</b>	Sets EEV to manual position.
<b>Configuration</b>	— <b>Rejection</b> <i>(only if no outdoor unit detected)</i>	— <b>Room (Reheat)</b>		Rejects heat to room when no outdoor unit.
		— <b>Pool Water</b>		Rejects heat to pool when no outdoor unit.
	— <b>Control Room</b>	— <b>MODBUS</b>		Default: supplied air thermostat
		— <b>BACnet</b>		BACnet control—see <a href="#">BACnet</a> section.
	— <b>Control Pool</b>	— <b>Setpoints</b>		Default: onboard temperature control
		— <b>BACnet</b>		BACnet control—see <a href="#">BACnet</a> section.
	— <b>Setpoints Method</b>	— <b>ICR</b>		Use internal sensor & sampling routine
		— <b>HTS/CTS</b>		Use external pool water temp. sensor
	— <b>OD Fan Reduction</b> <i>(only if outdoor unit detected)</i>	— <b>Reduction (%)</b>		Outdoor fan speed reduction in %.
	— <b>Time Delays</b>	— <b>Short Cycle</b>	— <b>value</b>	Short-cycle timer delay in minutes.
		— <b>Heat / Cool</b>	— <b>value</b>	Heat / cool timer delay in minutes.
	— <b>Units</b>	— <b>Standard</b>		Standard units.
		— <b>Metric</b>		Metric units (does not affect calibration units).
	— <b>Set Time</b>	— <b>Hours</b>	— <b>value</b>	Set the system hours.
		— <b>Minutes</b>	— <b>value</b>	Set the system minutes.
— <b>Set Date</b>	— <b>Day</b>	— <b>value</b>	Set the system day.	
	— <b>Month</b>	— <b>value</b>	Set the system month.	
	— <b>Year</b>	— <b>value</b>	Set the system year.	
<b>Calibration</b>	— <b>Suction 1</b>		Suction Pressure	Calibration in 1 psi intervals.
	— <b>Discharge 1</b>		Discharge Pressure	Calibration in 1 psi intervals.
	— <b>Vapour Line 1</b>		Suction line temp.	Calibration in 0.1°F intervals
	— <b>Outdoor Ambient</b>		(not used)	
	— <b>Outdoor IN Temp</b>		(not used)	
	— <b>Outdoor OUT Temp</b>		(not used)	
	— <b>Indoor IN Temp</b>		(not used)	
— <b>Indoor OUT Temp</b>		Pool water temp.	Calibration in 0.1°F intervals	

**NOTE:** Calibration is generally not required. Pressure sensors may be calibrated against a known source if needed. All temperature sensors have an Auto Calibration feature.

# BACnet Interface

The BACnet interface is an **MS/TP** connection via RS-485 twisted pair. BACnet **IP** is not available. Recommended wire: 22-24 AWG single twisted pair, 100-120 Ohms impedance, 17pF/ft or lower capacitance, with braided or aluminum foil shield, such as Belden 9841 or 89841.

The connector on the control board is a three wire removable screw connector. The signals are as follows:

- A: Communications line (+) (right pin)
- B: Communications line (-) (middle pin)
- C: Ground connection (left pin)

If connecting multiple units to one RS-485 connection point, connect the signal cable from the master building controller to the first unit. Connect the second unit to the first unit (in same connector), connect the third unit to the second unit, and so on until all units are connected (daisy-chain). Remove the TERM jumper (located just above the BACnet connector on control board) from all units except the last one. The shield ground should be connected only to the GND pin of the unit for single unit installations. For multiple units, the shield ground should only be connected to the GND pin of the last unit. The shield grounds for intermediate units should be connected together. The shield ground should be left unconnected at the building controller end for all cases.

Vendor: Maritime Geothermal Ltd.  
 Vendor ID: 260  
 Model Name: MGT GEN2 Control Board

The following parameters can be set via the PC App's *Configuration Window*:

- 1) **Baud rate**  
9600, 19200, 38400, or 76800
- 2) **MAC address**  
Maximum value is 125.
- 3) **Instance number**  
Maximum value is 4194303.

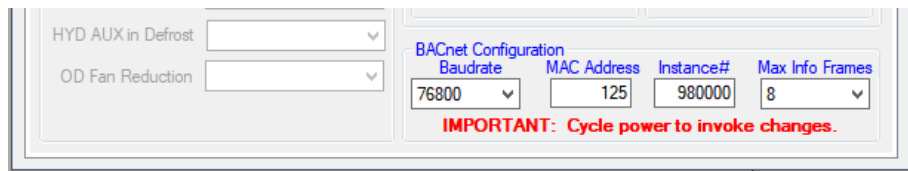

The BACnet parameter **Max\_Master** has a fixed value of **127** in this device.

BACnet data is available regardless of the selected control method. In order to control the unit via the BACnet interface, set **Control Source** to **BACnet** either by using the PC App's configuration window or the LCD menus.

TABLE 22 - BACnet OBJECTS - CONTROL SIGNALS (READ/WRITE)				
Name	Data Type	ID	Property	Description
SYSTEM_Y1A	Binary Value	BV0	Present Value	Pool water heat demand ( <i>PC-T only</i> )
SYSTEM_O	Binary Value	BV2	Present Value	Switch from air heat to cooling. Inactive= <b>HEATING</b> , Active= <b>COOLING</b>
SYSTEM_Y1	Binary Value	BV3	Present Value	Air heat or air cooling demand
SYSTEM_G	Binary Value	BV6	Present Value	Fan recirculation (active is on)
SYSTEM_DH	Binary Value	BV7	Present Value	Air dehumidify demand
BACnet_Units	Binary Value	BV9	Present Value	Select units for BACnet objects. OFF=US standard, ON=metric

**Note: object names are subject to change without prior notice.**

**TABLE 23 - BACnet OBJECTS - DATA (Read Only)**

	Name	ID	Property	Units	Description
Type - Analog Input	AI0 (Comp1_Current)	AI0	Present Value	Amps	Compressor current draw (AI0) - requires accessory
	AI1 (Comp2_Current)	AI1	Present Value	User	User defined (0-5VDC or 4-20mA)
	AI2	AI2	Present Value	User	User defined (0-5VDC or 4-20mA)
	AI3	AI3	Present Value	User	User defined (0-5VDC or 4-20mA)
	AI4 (CTS)	AI4	Present Value	degF (degC)	User defined (0-5VDC or 4-20mA)
	AI5 (HTS)	AI5	Present Value	degF (degC)	Pool water temperature from ext. sensor - requires accessory
	LPS1	AI6	Present Value	PSIG (kPa)	Low pressure value (suction pressure)
	HPS1	AI7	Present Value	PSIG (kPa)	High pressure value (discharge pressure)
	EVAP1	AI8	Present Value	degF (degC)	Evaporating Temperature
	COND1	AI9	Present Value	degF (degC)	Condensing Temperature
	Suction Line 1	AI10	Present Value	degF (degC)	Suction line temperature
	Superheat 1	AI11	<b>Setpoint Value</b>	degF (degC)	Superheat
	EEV1 Position	AI12	Present Value	%	EEV1 position (% open)
	LPS2	AI13	Present Value	PSIG (kPa)	N/A
	HPS2	AI14	Present Value	PSIG (kPa)	N/A
	EVAP2	AI15	Present Value	degF (degC)	N/A
	COND2	AI16	<b>Setpoint Value</b>	degF (degC)	N/A
	Suction Line 2	AI17	Present Value	degF (degC)	N/A
	Superheat 2	AI18	<b>Setpoint Value</b>	degF (degC)	N/A
	EEV2 Position	AI19	Present Value	%	N/A
	Outside Ambient	AI20	Present Value	degF (degC)	N/A
	O_IN	AI21	Present Value	degF (degC)	N/A
	O_OUT	AI22	Present Value	degF (degC)	N/A
	I_IN	AI23	Present Value	degF (degC)	N/A
I_OUT	AI24	Present Value	degF (degC)	Pool water temp. located on water IN pipe (PC-T only)	
Type - Analog Value	PWM_IN	AV0	Present Value	%	PWM input (from external source)
	PWM1 (OD Fan)	AV1	Present Value	%	AC2 Outdoor Fan speed (if AC2 present)
	PWM2	AV2	Present Value	%	PWM output value (spare)
	PWM3 (OV2)	AV3	Present Value	%	PWM output value (spare)
	PWM4 (IV2)	AV4	Present Value	%	PWM output value (spare)
	Operation Mode	AV5	Present Value	N/A	Description of mode - see Operation Mode Description table
	Limits description	AV6	Present Value	N/A	Description of active limits - see Limits Description table
	Permanent Alarms 1	AV7	Present Value	N/A	Descr. of active alarms - see Alarm Descriptions table
	Permanent Alarms 2	AV8	Present Value	N/A	N/A
	Board Faults	AV9	Present Value	N/A	Description of active faults - see Fault Descriptions table
Sensor Faults	AV10	Present Value	N/A	Description of active faults - see Fault Descriptions table	
Type - Binary Output	STAGE1	BO0	Present Value	N/A	Compressor contactor
	STAGE2	BO1	Present Value	N/A	N/A
	ICR (Indoor Circ)	BO2	Present Value	N/A	Pool water pump control (PC-T only)
	DO0 (OV1)	BO3	Present Value	N/A	N/A
	DO1 (IV1)	BO4	Present Value	N/A	N/A
	DO2 (HYD_AUX)	BO5	Present Value	N/A	N/A
	DO3 (AUX_ONLY)	BO6	Present Value	N/A	N/A
	PHS1	BO7	Present Value	N/A	Dry contact pin for locked out on alarm
PHS2	BO8	Present Value	N/A	N/A	
Type - Binary Value	CONTROLS	BV9	Present Value	N/A	Control indicator: 0=local (man.override), 1=remote (BACnet)
	Outdoor Flow	BV10	Present Value	N/A	N/A
	Indoor Flow	BV11	Present Value	N/A	N/A
	Phase Monitor1	BV12	Present Value	N/A	3-phase monitor - requires accessory
	Phase Monitor2	BV13	Present Value	N/A	N/A
	Comp Monitor1	BV14	Present Value	N/A	N/A
Comp Monitor2	BV15	Present Value	N/A	N/A	

**TABLE 24 - BACnet OBJECTS - OPERATION MODE Description (Read Only)**

Name	Data Type	ID	Present Value	Description
Operation Mode	Analog Value	AV5	1	Air Cooling
			6	Air Reheat
			7	Pool Heat ( <i>PC-T only</i> )
			9	OFF
			15	Air Reheat OFF
			16	Pool Heat OFF ( <i>PC-T only</i> )
			18	Air Cooling with DH demand
			19	Air Reheat with AC demand
			20	Air Reheat with DH demand
			21	Air Reheat with AC and DH demands
			22	Pool Heat with AC demand ( <i>PC-T only</i> )
			23	Pool Heat with DH demand ( <i>PC-T only</i> )
24	Pool Heat with AC and DH demands ( <i>PC-T only</i> )			

Note: Object is type Analog Value but value will always be an integer value.

**TABLE 25 - BACnet OBJECTS - LIMITS Description (Read Only)**

Name	ID	BIT #	Decimal Value*	Bit Description
Limits (Present Value)	AV6	1	2	High Indoor OUT (pool water) temperature ( <i>PC-T only</i> )

Note: Limits object is type Analog Value but value is bit coded and may be decoded as such (integer value).

Note \* : Value is for a single alarm and reference only.

**Note: object names are subject to change without prior notice.**

**TABLE 26 - BACnet OBJECTS - ALARM Descriptions (Read Only)**

Name	Data Type	ID	Description
AI0 (Comp1 Current)	Analog Input	AI0	Stage 1 Status alarm (Start / Stop Failure) - requires accessory
AI1 (Comp2 Current)	Analog Input	AI1	N/A
LPS1	Analog Input	AI6	Low pressure alarm
HPS1	Analog Input	AI7	High pressure alarm
LPS2	Analog Input	AI13	N/A
HPS2	Analog Input	AI14	N/A
Outdoor Flow	Binary Value	BV10	N/A
Indoor Flow	Binary Value	BV11	N/A
Phase Monitor1	Binary Value	BV12	Phase Monitor alarm - requires accessory
Phase Monitor2	Binary Value	BV13	N/A
Comp Monitor1	Binary Value	BV14	N/A
Comp Monitor2	Binary Value	BV15	N/A

Name	ID	BIT #	Decimal Value*	Bit Description
<b>Permanent Alarms 1</b> (Present Value)	<b>AV7</b>	0	1	Master permanent alarm (occurs when any alarm occurs)
		1	3	Low pressure heating mode alarm (suction pressure)
		2	5	Low pressure cooling mode alarm (suction pressure)
		3	9	High pressure heating mode alarm (discharge pressure)
		4	17	High pressure cooling mode alarm (discharge pressure)
		5	33	Loss of charge alarm
		6	65	Phase monitor alarm - requires accessory
		7	129	Compressor monitor alarm - N/A
		8	257	Status alarm - N/A
		14	16,385	N/A
		15*	32,769	N/A
<b>Permanent Alarms 2</b> (Present Value)	<b>AV8</b>	-	-	N/A

Note: Permanent Alarm objects are type Analog Value but values are bit coded and may be decoded as such (integer value).  
 Note \*: Value is for a single alarm and reference only. Value includes + 1 for Master Alarm

**Note: object names are subject to change without prior notice.**

go to TABLE OF CONTENTS

**TABLE 27 - BACnet OBJECTS - FAULT Descriptions (Read Only)**

Name	Data Type	ID	Description
AI4	Analog Input	AI0	N/A
AI5 (Hot Tank)	Analog Input	AI1	External pool water temp. sensor faulty or disconnected - requires accessory <i>(PC-T only)</i>
LPS1	Analog Input	AI6	Low pressure sensor faulty or disconnected
HPS1	Analog Input	AI7	High pressure sensor faulty or disconnected
LPS2	Analog Input	AI13	N/A
HPS2	Analog Input	AI14	N/A
Suction Line1	Analog Input	AI10	Suction line 1 temperature sensor faulty or disconnected.
Suction Line2	Analog Input	AI17	N/A
Outside Ambient	Analog Input	AI20	N/A
O_IN	Analog Input	AI21	N/A
O_OUT	Analog Input	AI22	N/A
I_IN	Analog Input	AI23	N/A
I_OUT	Analog Input	AI24	Internal pool water temperature sensor faulty or disconnected <i>(PC-T only)</i>

Name	ID	BIT #	Decimal Value*	Bit Description
<b>Board Faults</b> (Present Value)	<b>AV9</b>	0	1	Digital inputs
		1	2	Digital outputs
		2	4	PWM outputs
		3	8	Analog to digital conversion
		4	16	Real time clock
		5	32	EEPROM memory
		6	64	Menu buttons
		7	128	LCD Display
<b>Sensor Faults</b> (Present Value)	<b>AV10</b>	0	1	Suction line 1 temperature
		1	2	N/A
		2	4	Outdoor Ambient temperature - requires accessory
		3	8	Calibration temperature resistor plug
		4	16	N/A
		5	32	Internal pool water temperature sensor <i>(PC-T only)</i>
		6	64	N/A
		7	128	N/A
		8	256	N/A
9	512	External pool water temperature sensor on AI5 - requires accessory		

Note: Board and Sensor Fault objects are type Analog Value but values are bit coded and may be decoded as such (integer value).  
 Note \*: Value is for a single fault and reference only.

**Note: object names are subject to change without prior notice.**

# Startup Procedure

The PC-Series R410a Startup Record located in this manual is used in conjunction with this startup procedure to provide a detailed record of the installation. A completed copy should be left on site, a copy kept on file by the installer and a copy should be sent to Maritime Geothermal Ltd.

Check the boxes or fill in the data as each step is completed. For data boxes, circle the appropriate units.

## Pre-Start Inspection

### Ductwork:

1. Verify that all ductwork has been completed and is firmly attached to the unit. Verify that any dampers or diverters are properly set for operation of the unit.
2. Verify that all registers are open and clear of any objects that would restrict the airflow.
3. Verify that a new air filter is installed and the cover is secured.
4. Verify the condensate drain is connected, properly trapped, vented and free of debris.
5. Ensure the unit is sitting level to prevent overflow of the condensate drip tray.
6. If a plenum heater has been installed, verify that it is securely fastened to the ductwork.

### Pool Loop (*PC-T only*):

1. Verify there are no leaks in the connections to the unit.
2. Verify that the bypass is set up as per piping diagrams in this manual.

### Electrical:

1. **Ensure the power to the unit is off. Ensure the power to the plenum heater is off if equipped.**
2. Verify all high voltage connections. Ensure that there are no stray wire strands, all connections are tight and the ground wire is connected tightly to the ground connector.
3. Record the fuse / circuit breaker size and wire gauge for the unit.
4. Verify that the control connections to the unit are properly connected and all control signals are off, so that the unit will not start up when the power is turned on.
5. Verify that the pool pump contactor signal is routed through the terminals in the PC unit, if PC unit is to have control of pool pump. Record the voltage of the pump.
6. Ensure all access panels except the one that provides access to the electrical box are in place.
7. Connect a Windows laptop with the MG USB driver and PC App installed via USB cord to control board.

## Unit Startup

The unit is now ready to be started. The steps below outline the procedure for starting the unit and verifying proper operation of the unit. **It is recommended that safety glasses be worn during the following procedures.**

### Preparation:

1. Turn the power on to the unit and verify that the supplied air thermostat powers up. Also verify that the pool pump is running, or is ready to run if controlled by the PC Unit.
2. (*PC-T only*) Using the PC App and/or room thermostat, adjust setpoints as follows to prepare to run unit in Pool Water Heat mode:
  - Room RH Stage 1 Setpoint: 80% (or higher than current room humidity)
  - Room Temperature Stage 1 Setpoint: 50°F (or lower than current air temperature)
  - Room Temperature Auxiliary Setpoint: 50°F (or lower than current air temperature)
  - Pool Water Stage 1 Setpoint: 90°F (or higher than current pool water temperature)
3. **ENABLE** the system through the PC App's Tools-->Configuration menus or LCD interface. The unit should start within 5 minutes.
4. Measure the following voltages on the compressor contactor and record them on the startup sheet: L1-L2, L2-L3, L1-L3 (only L1-L2 for single phase units).

**Pool Water Heat Mode (PC-T only):**

1. Monitor the suction and discharge pressures in the PC App or the LCD interface. Adjust the flow through the unit as per diagram **002297PDG** until a discharge pressure of **350-400 psi** is obtained.
2. The suction pressure will depend on the room temperature, but it should be about **90-110 psi** for a typical start-up. Record the value after 10 minutes of run time.
3. Make the following setpoint changes:
  - Room Temperature Stage 1 Setpoint: 90°F (or higher than current air temperature)
  - Pool Water Stage 1 Setpoint: 70°F (or lower than current pool water temperature)The unit should switch to Air Reheat mode.

**Air Reheat Mode:**

1. Check the refrigeration gauges on the unit. The suction and discharge pressures will depend on the room temperature, but they should be ~ **90-110 psi** and **250-350 psi** respectively for a typical start-up.
2. Monitor the refrigeration gauges while the unit runs. Record the following after 10 minutes of runtime:
  1. Suction pressure
  2. Discharge pressure
  3. Duct Return temperature (poke a small hole in the flex collar and insert probe in airstream)
  4. Duct Supply temperature (poke a small hole in the flex collar and insert probe in airstream)
  5. Duct Delta T (should be between **4-9°F, (2-5°C)**)
  6. Compressor L1(C) current (black wire; place meter between electrical box and compressor)

**Electric Plenum Heat (if installed):**

1. Make the following setpoint change:
  - Room Temperature Auxiliary Setpoint: 90°F (or higher than current air temperature)
2. Remove the electrical cover from the plenum heater. Place a current clamp meter around one of the supply wires. Turn on the breaker to the plenum heater. Verify that the current draw increase as each stage of two stages is activated. Record the final current draw on the startup record.

**Heat Rejection Mode (if system is equipped with AC2-Series outdoor condenser):**

1. Make the following setpoint changes:
  - Room RH Stage 1 Setpoint: 10% (or lower than current room humidity)
  - Room Temperature Stage 1 Setpoint: 50°F (or lower than current air temperature)
  - Room Temperature Auxiliary Setpoint: 50°F (or lower than current air temperature)
  - Pool Water Stage 1 Setpoint: 70°F (or lower than current pool water temperature)

The unit should switch to heat rejection mode and the outdoor condenser fan should start. Verify that the suction and discharge pressures are approximately **90-110 psi** and **250-350 psi (higher if outdoor temperature is high)**. Record the values after 10 minutes of runtime.

**Final Inspection:**

1. Turn the power off to the unit (and plenum heater if installed) and remove all test equipment.
2. Install the electrical box cover on the PC unit. Install the electrical cover on the plenum heater if applicable.
3. Do a final check for leaks in the indoor (pool) loop system and ensure the area is clean.
4. Turn the power on to the unit and the plenum heater if installed. Set the controls to the final values and record them on the startup record.

**Startup Record:**

1. The installer should sign and date the Startup Record and have the homeowner sign as well. The installer should leave the Startup Record with the homeowner, retain a copy for filing, and send a copy to Maritime Geothermal Ltd. for warranty registration.

**Post Startup Verification:**

1. It is generally necessary to revisit the site after a few days to verify that the system is operating properly as it may take some time to bring the pool up to temperature.
2. Force the unit to pool water heat mode (if it is not already in it) and verify the discharge pressure of the unit. Adjust the flow rate as per 002297PDG to obtain a discharge pressure of **350-400 psi** again if required.
3. If the pool is not close to the final temperature, another visit and re-adjustment of the flow is recommended.



## Startup Record —PC-Series Size 45-80 R410a

Installation Site		Startup Date	Installer	
City			Company	
Province			Model	
Country			Serial #	
Homeowner Name		Homeowner Phone #		

Check boxes unless asked to record data, otherwise circle units

### PRE-START INSPECTION

<b>Ductwork</b>	Ductwork is completed, dampers/ diverters are adjusted					
	Registers are open and clear of objects					
	Air filter and end cap are installed					
	Condensate drain is connected, trapped, vented & free of debris					
	Unit is sitting level					
	Plenum heater is securely fastened (if applicable)					
<b>Pool Loop</b> <i>(PC-T only)</i>	No leaks in the connections to the PC unit ports					
	There is flow and bypass is setup as per drawing 002297PDG					
<b>Electrical</b>	High voltage connections are correct and securely fastened					
	Circuit breaker (or fuse) size and wire gauge for PC unit		A		Ga.	
	Circuit breaker (or fuse) size, wire gauge, and plenum heater size		A		Ga.	kW
	Low voltage connections are correct and securely fastened					



### STARTUP DATA

<b>Preparation</b>	Air and pool water setpoints are set at values listed in table						
	Voltage across L1 and L2, L1 and L3, L2 and L3					VAC	
<b>Pool Water Heat Mode</b>	Flow set for a discharge pressure of 350-400PSIG						
	Suction pressure after 10 minutes of runtime			psi	kPa		
	Unit switches to Air-Reheat mode						
<b>Air Re-Heat Mode (10 minutes)</b>	Suction Pressure / Discharge Pressure			psi	kPa		
	Duct Return, Duct Supply, and Delta T		In		Out	°F °C	
	Compressor L1 (black wire) current		A				
<b>Plenum Heater</b>	Current draw (all stages on)		A				
<b>Heat Rejection Mode</b>	Suction and discharge after 10 minutes of runtime			psi	kPa		
<b>Final Inspection</b>	Electrical box cover installed on unit and plenum heater						
	Piping leak free, area is clean						
	Dehumidification setpoint			%RH			
	Air temperature setpoint, delta				°F	°C	
	Pool water temperature setpoint, delta				°F	°C	

<b>Date:</b>		<b>Installer Signature:</b>		<b>Homeowner Signature:</b>	
--------------	--	-----------------------------	--	-----------------------------	--

A total of three copies are required: one for the homeowner, one for the installer, and one to be sent to Maritime Geothermal Ltd.

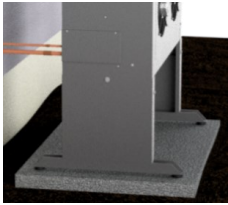
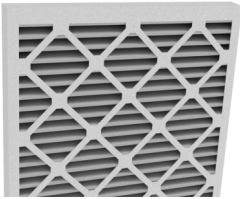
# Routine Maintenance

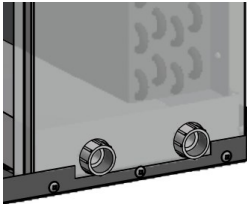
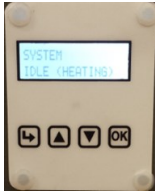
MAINTENANCE SCHEDULE			
Item		Interval	Procedure
Outdoor Unit (if present)		Weekly	Inspect for and clear away debris or leaves in air coil intake.
Air Filter		6 months	Inspect for dirt. Replace if necessary.
Compressor Contactor		1 year	Inspect for pitted or burned points. Replace if necessary.
Condensate Drain(s)		1 year	Inspect for clogs. Clean if necessary.
LCD Interface or PC App		When problem is suspected	Check for alarms and faults (only necessary if alarms not reported through a BACnet system). Rectify problem if alarms found. See <a href="#">Troubleshooting</a> chapter.

# Troubleshooting Guide



**WARNING: WHEN SERVICING THE OUTDOOR UNIT, BE SURE TO TURN OFF POWER TO THE INDOOR UNIT. The outdoor disconnect switch will not cut low voltage power, and damage to the control board will occur if the main unit breaker is not turned off during service.**

The following steps are for troubleshooting the pool conditioner. If the problem is with the plenum heater, proceed to that section at the end of the troubleshooting guide. Repair procedures and reference refrigeration circuit diagrams can be found later in this manual.

- STEP 1:** Verify that the LCD Interface is functioning . If it is not, proceed to POWER SUPPLY TROUBLESHOOTING, otherwise proceed to STEP 2.
- STEP 2:** Record the alarm shown on the LCD Interface or use the PC App Alarms page to determine the alarm type. Proceed to the ALARMS and/or FAULTS TROUBLESHOOTING section.
- STEP 3:** If there are no alarms and STAGE1 is showing ON (LCD Interface, PC App or LED on control board) but the compressor is not operating, does not attempt to start, attempts to start but cannot, starts hard, or starts but does not sound normal, proceed to the COMPRESSOR TROUBLESHOOTING section.
- STEP 4:** If the compressor starts and sounds normal, the compressor is OK and the problem lies elsewhere. Proceed to the OPERATION TROUBLESHOOTING section.
- NOTE:** To speed up the troubleshooting process, if using the PC Application, click on SC Override to reduce the short cycle timer to 10 seconds.

POWER SUPPLY TROUBLESHOOTING			
Fault	Possible Cause	Verification	Recommended Action
<b>No power to unit</b>	Disconnect switch open (if installed).	Verify disconnect switch is in the ON position.	Determine why the disconnect switch was opened; if all is OK close the switch.
	Fuse blown / breaker tripped.	At disconnect box, voltmeter shows 230VAC on the line side but not on the load side.	Reset breaker or replace fuse with proper size and type. (Time-delay type "D")
<b>No heartbeat on control board (blinking HB light at lower center of board)</b>	Transformer breaker tripped (or fuse blown for those without breaker).	Breaker on transformer tripped (or fuse looks burnt).	Push reset button. If it trips again locate cause of short circuit and correct (or replace fuse) .
	Faulty transformer.	Transformer breaker is not tripped (or fuse not blown), 230VAC is present across L1 and L3 of the compressor contactor but 24VAC is not present across 24VAC and COM of the control board.	Replace transformer.
	Faulty control board.	24VAC is present across 24VAC and COM of the control board.	Replace the control board.
<b>No display on air thermostat</b>	No power from control board.	See <b>No heartbeat on control board</b> above.	
	See also <b>Air Thermostat Troubleshooting</b> on a following page.		

ALARM TROUBLESHOOTING		
Alarm/Fault	Description	Recommended Action
The data logging function of the GEN2 Control Board is a very useful tool for troubleshooting alarms, providing a history of operation up to and including the time at which the alarm(s) occurred. Note that some alarms require accessories.		
<b>Low Pressure</b>	A low pressure alarm occurs when the suction pressure drops to or below the <b>Low Pressure Cutout</b> value. The low pressure is checked just before a compressor start; if it is OK the compressor will start, otherwise an alarm will occur. When the compressor starts, the low pressure alarm will be ignored for the number of seconds that <b>Low Pressure Ignore</b> is set to, after which the low pressure alarm will be re-enabled. This allows a dip in suction pressure below the cutout point during startup without causing a nuisance alarm.	Go to the Low Pressure section of the mode the unit was operating in at the time of the alarm.
<b>High Pressure</b>	A high pressure alarm occurs when the discharge pressure rises to or above the <b>High Pressure Cutout</b> value.	Go to the High Pressure section of the mode the unit was operating in at time of alarm.
<b>Compressor Status (accessory)</b>	This alarm occurs when there is a current draw on the compressor but no call for the compressor to be on (welded contactor) or when there is a call for the compressor to be on but there is no compressor current draw (manual high pressure control is open or contactor failure). Requires current sensor accessory.	Check contactor if compressor is staying on when it should be off. Go to Compressor section if compressor is not on when it should be.
<b>Comp. Not Pumping</b>	Discharge pressure is less than 30 psi higher than suction pressure after 2 minutes run time. It indicates leaking reversing valve, compressor very hot and tripped on internal overload, manual high pressure control trip, bad contactor, or defective compressor.	Check for reversing valve not seated properly, tripped manual high pressure control, or a contactor or compressor problem.
<b>Low Charge</b>	EEV position has been above 99% for 20 minutes within the first hour of cycle.	Check system for refrigerant leak. Also check EEV for proper operation (see <a href="#">EEV Troubleshooting</a> section)
<b>LOC (Loss of Charge)</b>	This alarm occurs if both the low pressure and high pressure sensors are below 30 psig (207 kPa).	Check system for refrigerant leak.

FAULT TROUBLESHOOTING		
Alarm/Fault	Description	Recommended Action
<b>Digital Inputs</b>	A failure has occurred and the indicated section of the control board may no longer work properly.	Cycle the power a few times; if the fault persists replace the control board.
<b>Digital Outputs</b>		
<b>Analog Inputs</b>		
<b>MODBUS Comms</b>		
<b>PWM Outputs</b>		
<b>Real Time Clock</b>		
<b>Flash Memory</b>	A failure has occurred and stored data may be corrupt.	It may be possible to correct this by using the menu item <b>Tools—Reset to Factory Defaults</b> . If this clears the fault then the system configuration will have to be set up again.
<b>Menu Buttons</b>	A failure has occurred and the control board may no longer respond to menu button key presses.	Try turning off the power, disconnecting and reconnecting the cable between the LCD Interface board and the Control Board, and then turning the power back on again. If this does not work then either the LDC Display board, the cable, or the driver section of the Control Board may be faulty.
<b>LCD Interface</b>	A failure has occurred and display may show erratic data, no data or may not turn on at all.	
<b>BACnet Comms</b>	BACnet communications experienced a timeout.	See below.
<b>Pressure Sensors</b>	The sensor is reading outside of the acceptable range. Check to ensure connector is on securely.	Replace the pressure sensor. If this does not rectify the problem, replace the control board.
<b>Temperature Sensors</b>	The sensor is reading outside of the acceptable range. Check to ensure connector is on securely.	Replace the temperature sensor. If this does not rectify the problem, replace the control board.

AIR THERMOSTAT TROUBLESHOOTING			
Fault	Possible Cause	Verification	Recommended Action
<b>Thermostat not working properly or giving erroneous readings</b>  <b>or</b> <b>MODBUS FAULT indication</b>	Faulty wiring between unit and thermostat	24VDC is not present across <b>POWER</b> and <b>GND</b> at the thermostat but is present across <b>24VDC</b> and <b>GND</b> at the lower right of control board.	Verify correct wiring with twisted pair wire in the <a href="#">Wiring</a> chapter. Correct the wiring as necessary.
		Disconnect wire and check continuity by connecting wires together at one end and measuring for close to zero resistance at other end.	Replace twisted pair wire if open circuit is found.
	Hardware problem on heat pump control board	24VDC is not present across <b>24VDC</b> and <b>GND</b> at the lower right of control board.	Replace board if voltage not correct.
		Remove MODBUS screw terminal connector from board as well as jumper from <b>TERM</b> (located just above the MODBUS connector). Using a multimeter set to DC volts with negative probe on <b>B</b> and positive probe on <b>A</b> , confirm there is <b>+2.5VDC</b> .	Replace board if voltage not correct.
	MODBUS termination problem	Verify MODBUS <b>TERM</b> jumper is in place on control board.	Install jumper if missing.
Faulty thermostat	24VDC is present across <b>POWER</b> and <b>GND</b> at the thermostat, wiring and termination are correct, and thermostat settings have been verified against the table in <a href="#">Operation</a> chapter; but problem persists.	Replace thermostat.	

BACnet TROUBLESHOOTING			
Fault	Possible Cause	Verification	Recommended Action
<b>BACnet communications not working properly</b>  <b>or</b> <b>BACnet FAULT indication</b>	Selected baud rate does not match building control system	Check baud rate of system.	Adjust BACnet parameters in the PC App's <a href="#">Tools--&gt;Configuration</a> window. <b>Cycle power to invoke any changes.</b>
	Selected MAC address and/or Instance # conflict with other devices on the network	Check MAC address and Instance # in relation to other system devices.	
	BACnet wiring or termination problem	Verify correct twisted pair wire and termination in the <a href="#">BACnet Interface</a> chapter (earlier).	Correct wiring.
	Hardware problem on heat pump control board	Remove BACnet screw terminal connector from board as well as jumper from <b>TERM</b> (located just above the BACnet connector). Using a multimeter set to DC volts with negative probe on <b>B</b> and positive probe on <b>A</b> , confirm there is <b>+2.5VDC</b> .	Replace board if voltage not correct.

<b>COMPRESSOR TROUBLESHOOTING</b>			
<b>Fault</b>	<b>Possible Cause</b>	<b>Verification</b>	<b>Recommended Action</b>
<b>Compressor will not start</b>	Faulty control board	No 24vac output on STAGE1 when compressor should be operating.	Replace control board.
	Faulty run capacitor (single phase only)	Check value with capacitance meter. Should match label on capacitor. Compressor will hum while trying to start and then trip its overload.	Replace if faulty.
	Loose or faulty wiring	Check all compressor wiring, including inside compressor electrical box.	Fix any loose connections. Replace any damaged wires.
	Faulty compressor contactor	Voltage on line side with contactor held closed, but no voltage on one or both terminals on the load side. Points pitted or burned. Or, 24VAC across coil but contactor will not engage.	Replace contactor.
	Thermal overload on compressor tripped	Ohmmeter shows reading when placed across R and S terminals and infinity between C & R or C & S. A valid resistance reading is present again after the compressor has cooled down.	Proceed to Operation Troubleshooting (particularly <i>high suction pressure</i> and <i>high discharge pressure</i> ) to determine the cause of the thermal overload trip.
	Burned out motor (open winding)	Remove wires from compressor. Ohmmeter shows infinite resistance between any two terminals. Note: Be sure compressor overload has had a chance to reset. If compressor is hot this may take several hours.	Replace the compressor.
	Burned out motor (shorted windings)	Remove wires from compressor. Resistance between any two terminals is below the specified value.	Replace the compressor.
	Motor shorted to ground	Remove wires from compressor. Check for infinite resistance between each terminal and ground.	If any terminal to ground is not infinite replace the compressor.
Seized compressor due to locked or damaged mechanism	Compressor attempts to start but trips its internal overload after a few seconds. (Run capacitor already verified)	Attempt to "rock" compressor free. If normal operation cannot be established, replace compressor.	
<b>Compressor starts hard</b>	Start capacitor faulty (single phase only)	Check with capacitance meter. Check for black residue around blowout hole on top of capacitor.	Replace if faulty. Remove black residue in electrical box if any.
	Potential relay faulty (single phase only)	Replace with new one and verify compressor starts properly.	Replace if faulty.
	Compressor is "tight" due to damaged mechanism	Compressor attempts to start but trips its internal overload after a few seconds. Run capacitor has been verified already.	Attempt to "rock" compressor free. If normal operation cannot be established, replace compressor.

<b>OPERATION TROUBLESHOOTING - AIR REHEAT MODE</b>			
<b>Fault</b>	<b>Possible Cause</b>	<b>Verification</b>	<b>Recommended Action</b>
<b>Will not switch to air reheat mode</b>	Faulty 4-way reversing valve solenoid coil (RV1)	Verify solenoid by removing it from the shaft while unit is running. There should be a loud "whoosh" sound".	Replace solenoid if faulty.
	Faulty 4-way reversing valve (RV1)	A click can be heard when the coil is energized, but unit continues to run in pool water heat mode.	Replace reversing valve if faulty.
<b>High or low suction or discharge pressure</b>	Faulty sensor	Compare pressure sensor reading against a known reference such as a new refrigeration manifold set.	Check wiring, replace sensor. If problem persists, replace control board.
<b>High discharge pressure</b>	Low or no indoor airflow	See Indoor Fan Troubleshooting section	Correct the problem.
	EEV stuck almost closed or partially blocked by foreign object	Manually adjusting the EEV does not affect the superheat or the suction pressure. High superheat and low discharge pressure.	Go to EEV troubleshooting section.
	Filter-dryer plugged	Feel each end of the filter-dryer; they should be the same temperature. If there is a temperature difference then it is plugged. Also causes low suction pressure.	Replace filter-dryer.
	Unit is overcharged (only possible if unit has been field serviced and incorrectly charged)	High subcooling, low delta T across air coil.	Remove 1/2 lb of refrigerant at a time and verify that the discharge pressure reduces. Or remove charge and weigh back in the amount listed on nameplate.
<b>Low suction pressure</b>	Low or no indoor airflow	See Indoor Fan Troubleshooting section	Correct the problem.
	Entering air temperature too cold	Should be above 60°F (16°C). Most likely will only occur during initial startup.	Use the electric plenum heater to warm up the room.
	TS1 temperature sensor not reading properly	If the sensor is reading low it will cause the superheat to appear high, which causes the EEV to continually close.	Verify EEV position is low compared to normal. Check temperature sensor, replace if necessary.
	Filter-dryer plugged	Feel each end of the filter-dryer; they should be the same temperature. If there is a temperature difference then it is plugged. Also causes high discharge pressure.	Replace filter-dryer.
	EEV stuck almost closed or partially blocked by foreign object	Manually adjusting the EEV does not affect the superheat or the suction pressure. High superheat and discharge pressure.	Go to EEV troubleshooting section.
	Low refrigerant charge	Superheat is high, EEV position is high.	Locate the leak and repair it. Spray Nine, a sniffer, and/or dye are common methods of locating a leak.



**OPERATION TROUBLESHOOTING - AIR REHEAT MODE**

<b>Fault</b>	<b>Possible Cause</b>	<b>Verification</b>	<b>Recommended Action</b>
<b>High suction pressure (may appear to not be pumping)</b>	EEV stuck open	Manually adjusting the EEV does not affect the superheat or the suction pressure. Low superheat and discharge pressure.	Go to EEV troubleshooting section.
	Leaking 4-way (reversing) valve, RV1 or RV2 (can cause compressor to overheat and trip internal overload)	One of the reversing valves is the same temperature on both ends of body, common suction line is warm, compressor is running hot.	Tap reversing valve, and switch it back and forth between heating and cooling positions. If this does not work, replace reversing valve.
	Leaking check valve between pool water coil and receiver	Check valve is cold to the touch and does not warm up.	Replace check valve.
	Leaking check valve in outdoor condenser return line to receiver	Check valve is cold to the touch and does not warm up.	Replace check valve.
	Faulty compressor, not pumping	Pressures change only slightly from static values when compressor is started.	Replace compressor.
<b>Compressor frosting up</b>	See Low Suction Pressure in this section		
<b>EEV frosting up</b>	EEV stuck almost closed or partially blocked by foreign object	Manually adjusting the EEV does not affect the superheat or the suction pressure. High superheat and discharge pressure.	Go to EEV troubleshooting section.
<b>Random high or low pressure trip (may not occur while on site)</b>	Intermittent indoor fan problem	See Indoor Fan Troubleshooting section.	Correct the problem.
<b>Random manual high pressure trip (may not occur while on site)</b>	Faulty compressor contactor	Points pitted or burned. Contactor sometimes sticks causing the compressor to run when it should be off.	Replace contactor.

**OPERATION TROUBLESHOOTING - POOL WATER HEAT MODE** (PC-T only)

Fault	Possible Cause	Verification	Recommended Action
<b>High or low suction or discharge pressure</b>	Faulty sensor	Compare pressure sensor reading against a known reference such as a new refrigeration manifold set.	Check wiring, replace sensor. If problem persists, replace control board.
<b>High discharge pressure</b>	Low or no pool water flow	Adjust the bypass valves (if present) to obtain a discharge pressure of 350-400 psi as per diagram in this manual. Check for restrictions in the water lines and verify pump sizing.	Correct any flow restriction or pump undersizing problem.
	Dirty or fouled coaxial heat exchanger	Disconnect the water lines (PVC unions) and inspect the inside of the pipes for scale deposits.	Flush the heat exchanger as per the General Maintenance section.
	EEV stuck almost closed or partially blocked by foreign object	Manually adjusting the EEV does not affect the superheat or the suction pressure. High superheat and low suction pressure.	Go to EEV troubleshooting section.
	Filter-dryer plugged	Feel each end of the filter-dryer; they should be the same temperature. If there is a temperature difference then it is plugged. Also causes low suction pressure.	Replace filter-dryer.
	Unit is overcharged (only possible if unit has been field serviced and incorrectly charged)	High subcooling, low delta T across water coil.	Remove 1/2 lb of refrigerant at a time and verify that the discharge pressure reduces.
<b>Low suction pressure</b>	Low or no airflow	See Indoor Fan Troubleshooting section.	Correct the problem.
	Entering air temperature too cold	Should be above 60°F (16°C). Most likely will only occur during initial startup.	Use the electric plenum heater to warm up the room.
	TS1 temperature sensor not reading properly	If the sensor is reading low it will cause the superheat to appear high, which causes the EEV to continually close.	Verify EEV position is low compared to normal. Check temperature sensor, replace if necessary.
	Filter-dryer plugged	Feel each end of the filter-dryer; they should be the same temperature. If there is a temperature difference then it is plugged. Also causes high discharge pressure.	Replace filter-dryer.
	EEV stuck almost closed or partially blocked by foreign object	Manually adjusting the EEV does not affect the superheat or the suction pressure. High superheat and discharge pressure.	Go to EEV troubleshooting section.
	Low refrigerant charge	Superheat is high, EEV position is high.	Locate the leak and repair it. Spray Nine, a sniffer, and/or dye are common methods of locating a leak.

**OPERATION TROUBLESHOOTING - POOL WATER HEAT MODE** (PC-T only)

<b>Fault</b>	<b>Possible Cause</b>	<b>Verification</b>	<b>Recommended Action</b>
<b>High suction pressure (may appear to not be pumping)</b>	EEV stuck open	Manually adjusting the EEV does not affect the superheat or the suction pressure. Low superheat and discharge pressure.	Go to EEV troubleshooting section.
	Leaking 4-way (reversing) valve, RV1 or RV2 (can cause compressor to overheat and trip internal overload)	One of the reversing valves is the same temperature on both ends of body, common suction line is warm, compressor is running hot.	Tap reversing valve, and switch it back and forth between heating and cooling positions. If this does not work, replace reversing valve.
	Leaking check valve between air condenser coil and receiver	Check valve is cold to the touch and does not warm up.	Replace check valve.
	Leaking check valve in outdoor condenser return line to receiver	Check valve is cold to the touch and does not warm up.	Replace check valve.
	Faulty compressor, not pumping	Pressures change only slightly from static values when compressor is started.	Replace compressor.
<b>Compressor frosting up</b>	See Low Suction Pressure in this section		
<b>EEV frosting up</b>	EEV stuck almost closed or partially blocked by foreign object	Manually adjusting the EEV does not affect the superheat or the suction pressure. High superheat and discharge pressure.	Go to EEV troubleshooting section.
<b>Random low pressure trip (may not occur while on site)</b>	Intermittent indoor fan problem	See Indoor Fan Troubleshooting section.	Correct the problem.
<b>Random high pressure trip (may not occur while on site)</b>	Faulty indoor circulator relay (if pool pump is controlled by PC unit)	Using the PC APP, manually turn the ICR on/off several times and ensure the circulator(s) start and stop.	Replace relay.
<b>Random manual high pressure trip (may not occur while on site)</b>	Faulty compressor contactor	Points pitted or burned. Contactor sometimes sticks causing the compressor to run when it should be off.	Replace contactor.

<b>OPERATION TROUBLESHOOTING - HEAT REJECTION MODE</b>			
<b>Fault</b>	<b>Possible Cause</b>	<b>Verification</b>	<b>Recommended Action</b>
<b>Will not switch to heat rejection mode</b>	Faulty 4-way reversing valve solenoid coil (RV2)	Verify solenoid by removing it from the shaft while unit is running. There should be a loud "whoosh" sound".	Replace solenoid if faulty.
	Faulty 4-way reversing valve (RV2)	A click can be heard when the coil is energized, but unit continues to run in pool water heat mode.	Replace reversing valve if faulty.
<b>Pool water heat mode instead of heat rejection mode</b>	Faulty 4-way reversing valve solenoid coil (RV1)	Verify solenoid by removing it from the shaft while unit is running. There should be a loud "whoosh" sound".	Replace solenoid if faulty.
	Faulty 4-way reversing valve (RV1)	A click can be heard when the coil is energized, but unit continues to run in pool water heat mode.	Replace reversing valve if faulty.
<b>High or low suction or discharge pressure</b>	Faulty sensor	Compare pressure sensor reading against a known reference such as a new refrigeration manifold set.	Check wiring, replace sensor. If problem persists, replace control board.
<b>High discharge pressure</b>	Low or no outdoor unit (AC2) airflow	See Outdoor Fan Troubleshooting section.	Correct the problem.
	Dirty or plugged outdoor air coil	Inspect.	Remove debris.
	Outdoor air too hot	Outdoor temperature limit for AC2 operation is 120F / 49 C.	Shut down until outdoor air is cooler.
	EEV stuck almost closed or partially blocked by foreign object	Manually adjusting the EEV does not affect the superheat or the suction pressure. High superheat and low discharge pressure.	Go to EEV troubleshooting section.
	Filter-dryer plugged	Feel each end of the filter-dryer; they should be the same temperature. If there is a temperature difference then it is plugged. Also causes low suction pressure.	Replace filter-dryer.
	Unit is overcharged (only possible if unit has been field serviced and incorrectly charged)	High subcooling, low delta T across air coil.	Remove 1/2 lb of refrigerant at a time and verify that the discharge pressure reduces.
<b>Low suction pressure</b>	Low or no indoor unit (PC) airflow	See Indoor Fan Troubleshooting section. Note that low airflow will cause the air coil to ice up once the suction pressure drops below 90 psi.	Correct the problem.
	TS1 temperature sensor not reading properly	If the sensor is reading low it will cause the superheat to appear high, which causes the EEV to continually close.	Verify EEV position is low compared to normal. Check temperature sensor, replace if necessary.
	Filter-dryer plugged	Feel each end of the filter-dryer; they should be the same temperature. If there is a temperature difference then it is plugged. Also causes high discharge pressure.	Replace filter-dryer.

<b>OPERATION TROUBLESHOOTING - HEAT REJECTION MODE</b>			
<b>Fault</b>	<b>Possible Cause</b>	<b>Verification</b>	<b>Recommended Action</b>
<b>Low suction pressure (continued)</b>	EEV stuck almost closed or partially blocked by foreign object	Manually adjusting the EEV does not affect the superheat or the suction pressure. High superheat and discharge pressure.	Go to EEV troubleshooting section.
	Low refrigerant charge	Superheat is high, EEV position is high.	Locate the leak and repair it. Spray Nine, a sniffer, and/or dye are common methods of locating a leak.
<b>High suction pressure (may appear to not be pumping)</b>	EEV stuck open	Manually adjusting the EEV does not affect the superheat or the suction pressure. Low superheat and discharge pressure.	Go to EEV troubleshooting section.
	Leaking 4-way (reversing) valve, RV1 or RV2 (can cause compressor to overheat and trip internal overload)	One of the reversing valves is the same temperature on both ends of body, common suction line is warm, compressor is running hot.	Tap reversing valve, and switch it back and forth between heating and cooling positions. If this does not work, replace reversing valve.
	Leaking check valve between pool water coil and receiver	Check valve is cold to the touch and does not warm up.	Replace check valve.
	Leaking check valve between air condenser coil and receiver	Check valve is cold to the touch and does not warm up.	Replace check valve.
	Faulty compressor, not pumping	Pressures change only slightly from static values when compressor is started.	Replace compressor.
<b>Compressor frosting up</b>	See Low Suction Pressure in this section		
<b>EEV frosting up</b>	EEV stuck almost closed or partially blocked by foreign object	Manually adjusting the EEV does not affect the superheat or the suction pressure. High superheat and discharge pressure.	Go to EEV troubleshooting section.
<b>Random low pressure trip (may not occur while on site)</b>	Intermittent indoor fan problem	See Indoor Fan Troubleshooting section.	Correct the problem.
<b>Random manual high pressure trip (may not occur while on site)</b>	Faulty compressor contactor	Points pitted or burned. Contactor sometimes sticks causing the compressor to run when it should be off.	Replace contactor.

INDOOR FAN/BLOWER TROUBLESHOOTING			
Fault	Possible Cause	Verification	Recommended Action
Low indoor airflow	Dirty air filter	Inspect.	Replace.
	Dirty air coil	Inspect.	Clean.
	Poor ductwork	Measure delta T between supply and return ducts at the unit. In heating mode, it should not be above 30°F(17°C).	The ECM fan will provide proper airflow up to 0.5 inH <sub>2</sub> O. The ductwork is poorly designed or greatly undersized if the fan motor cannot provide the required airflow.
	Airflow selected is too low	Check airflow settings on Indoor Fan page of the PC APP.	Select a higher setting.
	Airflow reduction is enabled	AR1 and AR2 are connected with a dry contact or jumper.	Airflow reduction may not be feasible with lower airflow selections. Increase settings until unit operates properly.
Indoor fan not operating at correct speeds.	Wrong model size selected	Verify that the model size is correct on the Configuration Page of the PC APP.	Select the correct model size.
Indoor fan not operating or operating intermittently	Fan control signal harness and/or fan power harness is loose	Verify that the connector is properly inserted into the fan motor. Gently tug on each wire to verify it is properly inserted into the connector.	Repair any loose connections.
	Control board not configured properly	Verify that the model series is correct on the Configuration Page of the PC APP.	Correct the configuration. If the wrong series is selected there may be no fan output.
	Faulty control board outputs  <b>Note: cycle the power once to see if the fan begins operating properly first</b>	Create a demand for any operating mode, which will activate the fan.  On the ECM Fan connector on the left side of the control board: 1) verify that there is 12 to 20VDC between pin G (grey wire) and pin C (white wire). 2) Verify that there is 2 to 6VDC between pin P (dark green wire) and pin C (white wire)	If there is no voltage present on either of the pins (G/P to C), replace the control board.  Ensure control board model series is correct, see above.
	Faulty control signal harness or faulty motor head	Create a demand for any operating mode, which will activate the fan.  On the ECM Fan connector at the fan motor: 1) verify that there is 12 to 20VDC between pin G (grey wire) and pin C (white wire). 2) Verify that there is 2 to 6VDC between pin P (dark green wire) and pin C (white wire)	If proper signal isn't present, replace the fan control signal harness. If proper signal is present, replace fan motor.
	Faulty fan power harness or faulty motor	Insert the tips of the voltmeter probes into the back of the connector at the fan to measure the voltage across the red and black wires. Value should be ~230VAC.	Replace power harness if 230VAC is not present, replace motor if 230VAC is present.

<b>PLENUM HEATER TROUBLE SHOOTING</b>			
<b>Fault</b>	<b>Possible Cause</b>	<b>Verification</b>	<b>Recommended Action</b>
<b>No 230VAC across plenum heater L1 and L2</b>	Disconnect switch open (if installed)	Verify disconnect switch is in the ON position.	Determine why the disconnect switch was opened, if all is OK close the switch.
	Fuse blown / breaker tripped	At plenum heater disconnect box (if installed), voltmeter shows voltage on the line side but not on the load side. Check if breaker is tripped.	Reset breaker or replace fuse at plenum heater disconnect box. Replace fuse with proper size and type. (Time-delay type "D")
	Same "Line" to L1 and L2	Measuring L1 to ground and L2 to ground both yield 115VAC, but L1 to L2 yields 0VAC.	Correct wiring.
<b>No 24VAC signal from C to ground at the plenum heater control board</b>	Plenum heater transformer is burned out	Voltmeter does not show 24VAC across transformer secondary.	Replace transformer.
	Plenum heater control board is faulty	Transformer tested OK in previous step.	Replace control board.
<b>No 24VAC signal from 1 to ground at the plenum heater control board</b>	Faulty wiring	24VAC present across C and ground at the plenum heater, but not across ground of the plenum heater and CP of the unit terminal strip.	Correct wiring.
		If previous step tested OK, 24VAC is present across ground of the plenum heater and 1 of the unit terminal strip, but not across ground of the plenum heater and 1 of the plenum heater.	Correct wiring.
<b>Plenum heater thermal overload is tripped.</b>	Indoor fan not operating	See Indoor Fan/Blower Troubleshooting section.	Correct problem. Reset overload.
	Plenum heater is not positioned so that majority of airflow passes over elements (if installed in ductwork outside unit)	Plenum heater meant for internal unit installation is installed in a larger duct outside unit, or is positioned after duct elbow.	Reposition plenum heater, or obtain a plenum heater model with a wider element cage (contact Maritime Geothermal).

<b>OUTDOOR FAN TROUBLESHOOTING</b>			
<b>Fault</b>	<b>Possible Cause</b>	<b>Verification</b>	<b>Recommended Action</b>
<b>Fan not operating or operating intermittently</b>	Fan power connections	Check for 208-277VAC across L1 and L2 of the Outdoor Unit. Proceed to next step if voltage present.	If no voltage present, verify that the connections are tight in both the indoor and outdoor units. Gently tug on each wire to verify connection is good. Repair any loose connections.
	Faulty PWM signal from PC control board	Use manual mode of the PC APP to set the outdoor fan to 50%. Using a multi-meter set to VDC, measure PWM1 to GND of the GEN2 control board in the Indoor Unit. It should be ~5VDC. Proceed to next step if voltage present.	If signal is not present the control board may be faulty. Try cycling the power and retesting. If this does not correct the problem replace the control board.
	Fan PWM signal connections	Use manual mode of PC APP to set the outdoor fan to 50%. Using a multi-meter set to VDC, measure PWM+ to ground in the Outdoor Unit. It should be ~5VDC. Proceed to next step if voltage present.	If signal is not present, check connections of PWM wire and ground wire. Replace wiring if connections are good.
	Faulty fan motor	All of the above checks have been performed and everything is OK.	Replace fan motor.

## EEV (Electronic Expansion Valve) TROUBLESHOOTING

Electronic expansion valves are a great advancement over TVX's, allowing more precise refrigerant control, but they do have a couple of limitations.

- a) EEV's receive commands to open or close from the control board, but they don't send any feedback to the control board to confirm that command has been received and acted upon. If they aren't reliably acted upon (due to pulses missed due to a wiring issue or EEV being mechanically stuck), the actual valve opening position won't match what the control board thinks it is. In extreme cases, the resulting repeated commands can cause the *apparent* valve position to go to **15%** (minimum) or **100%**, when the valve is actually in between.
- b) A restriction in the refrigeration circuit (particularly the liquid line, e.g. plugged filter-dryer) or shortage of refrigerant due to a leak can cause a similar issue. If the EEV opens to allow more refrigerant flow to lower the superheat but liquid refrigerant is not available at its inlet, the EEV will continue to open to attempt to let more refrigerant through and will work its way towards **100%** (full open). **High superheat** is also a symptom.

If there is low suction pressure and the EEV position is also low then the problem is generally not in the refrigeration system; check the water or airflow of the indoor or outdoor loop, whichever is currently the cold side (evaporator).

### Tests to determine if an EEV is working

- Sound test: turn the power to the heat pump off and back on again. Or manually set the EEV to 25% and wait for it to stop, then set the EEV to "-1%". Both actions will cause the EEV to overdrive closed. You should hear the valve clicking and then the clicking should change and get louder when the valve reaches 0%. If there is no sound, then it is likely that the EEV is faulty or stuck.
- Using the PC APP, put the system in manual override mode. Manually adjust the EEV position by at least 25% either up or down and check to see that the suction pressure, discharge pressure and superheat react to the change. If there is no reaction, then it is likely that the EEV is faulty or stuck.
- Set the EEV back to AUTO and then turn the heating or cooling demand off (but leave power on). Once the demand is off, if the EEV is working then the discharge pressure should remain significantly higher than the suction pressure, i.e. the system will not equalize (since EEV's are closed when there is no demand). If the system does equalize it is likely that the EEV is not working and is partially open.

There are 3 possible causes for EEV problems: the control board is not working properly, the wire/cable is faulty, or the EEV is faulty.

### The EEV can be checked electrically:

- RED to GREEN 75ohms
- WHITE to BLACK 75ohms

If this test fails, EEV is bad and should be replaced, but if it passes it still may be mechanically defective.

### Check with a new EEV:

A further check that can be performed is to connect a new EEV and cable to the control board and visually check the EEV so see if it opens and closes by setting the position to 0 and 100% If the new EEV works then the EEV in the unit or the cable needs to be replaced.

- 1) Connect a test EEV and test cable to the control board.
- 2) Set the EEV position to 0%.
- 3) Set the EEV position to 100% and then listen for clicking and watch to see if the pintle in the EEV moves open.
- 4) Set the EEV position to 0% and then listen for clicking and watch to see if the pintle in the EEV moves closed.
- 5) If the EEV does not move in one or both directions then the control board must be replaced.
- 6) If the test EEV moves in both directions then either the cable or the EEV in the unit is faulty.
- 7) Disconnect the test EEV from the test cable and connect it to the cable in the unit.
- 8) Repeat steps 2 to 4.
- 9) If the test EEV moves in both directions then the EEV in the unit is faulty and must be replaced.
- 10) If the test EEV does not move in one or both directions then the cable must be replaced.



# Repair Procedures



**WARNING: WHEN SERVICING THE OUTDOOR UNIT, BE SURE TO TURN OFF POWER TO THE INDOOR UNIT. The outdoor disconnect switch will not cut low voltage power, and damage to the control board will occur if the main unit breaker is not turned off during service.**

## Pumpdown Procedure

1. Place the unit in SERVICE mode via the PC App or LCD interface; this will open the EEVs and start the indoor circulator (as long that circulator is powered and controlled by the unit). **DO NOT** turn off electrical power at the breaker panel, since the coaxial coil **must have full water flow** during refrigerant recovery. Be sure to **TURN OFF POWER** to indoor unit after pumpdown is completed, as per above warning.
2. Connect the refrigerant recovery unit to the unit's internal service ports via a refrigeration charging manifold and to a recovery tank as per the instructions in the recovery unit manual. Plan to dispose of refrigerant if there was a compressor burnout.
3. All refrigerant to water heat exchangers (coaxial coils, brazed plates) **must either have full flow or be completely drained** of fluid before recovery begins. Failure to do so can freeze and rupture the heat exchanger, voiding its warranty. (Note that this does not apply to desuperheater coils.)
4. Ensure all hose connections are properly purged of air. Start the refrigerant recovery as per the instructions in the recovery unit manual.
5. Allow the recovery unit suction pressure to reach a vacuum. Once achieved, close the charging manifold valves. Shut down, purge and disconnect the recovery unit as per the instructions in its manual. Ensure the recovery tank valve is closed before disconnecting the hose to it.
6. Connect a nitrogen tank to the charging manifold and add nitrogen to the unit until a positive gauge pressure of 5-10 psig is reached. This prevents air from being sucked into the unit by the vacuum when the hoses are disconnected.

**Turn off power** to unit. The unit is now ready for repairs.

## General Repair Procedure

1. Perform repairs to system.
  - Always ensure nitrogen is flowing through the system at the lowest flow rate that can be felt at the discharge during any brazing procedures to prevent soot buildup inside the pipes.
  - It is recommended to replace the liquid line filter-dryer any time the refrigeration system has been exposed to the atmosphere.
  - Place a wet rag around any valves being installed, as almost all valve types have non-metallic seats or seals that will be damaged by excessive heat, and aim the torch flame away from the valve body. Solder only one joint at a time and cool joints down in between.
2. Pressure test the system with nitrogen. It is recommended to check for leaks using leak detection spray, Spray Nine, or soapy water. Check at 10, 25, 50 and 100 psig. Allow the system to sit at 100 psig for at least an hour, then re-check. With a laptop connected, the **PC App** may be used to graph the nitrogen pressure (**Graphs** menu--> **Refrigeration Pressure and Temperature Graphs**) to make any downward trend due to a leak apparent. Be aware that changing room temperature can also cause upward or downward trends in nitrogen pressure.

## Vacuumping & Charging Procedure

After completion of repairs and nitrogen pressure testing, the refrigeration circuit is ready for vacuumping.

1. Release the nitrogen pressure and connect the vacuum pump to the charging manifold. Start the vacuum pump and open the charging manifold valves. Vacuum until the vacuum gauge remains at less than 500 microns for at least 1 minute with the vacuum pump valve closed.
2. Close the charging manifold valves then shut off and disconnect the vacuum pump. Place a refrigerant tank with the proper refrigerant on a scale and connect it to the charging manifold. Purge the hose to the tank.
3. Weigh in the appropriate amount **and type** of refrigerant through the low pressure (suction) service port. Refer to the nameplate label on the unit for the proper refrigerant type and charge amount.
4. If the unit will not accept the entire charge, the remainder can be added through the low pressure service port after the unit has been restarted.

## Compressor Replacement Procedure

1. Pump down the unit as per the Pumpdown Procedure above. **If there was a compressor burn out (motor failure), the refrigerant cannot be reused and must be disposed of according to local codes.**
2. Disconnect piping.
3. Replace the compressor. Replace the liquid line filter-dryer. Always ensure nitrogen is flowing through the system at the lowest flow rate that can be felt at the discharge during any brazing procedures to prevent soot buildup inside the pipes.
4. Vacuum the unit as per above procedure.
5. If there was a compressor burnout:
  - a) Charge the unit with **new** refrigerant and operate it for continuously for 2 hours. Pump down the unit and replace the filter-dryer. Vacuum the unit as per above procedure.
  - b) Charge the unit (refrigerant can be re-used) and operate it for 2-3 days. Perform an acid test. If it fails, pump down the unit and replace the filter-dryer.
  - c) Charge the unit (refrigerant can be re-used) and operate it for 2 weeks. Perform and acid test. If it fails, pump down the unit and replace the filter-dryer.
6. Charge the unit a final time. Unit should now be clean and repeated future burn-outs can be avoided.

## Outdoor Fan Replacement Procedure

1. Turn of the power to the Indoor Unit. This will ensure that power and control signals are off in the outdoor unit.
2. Remove the two screws that hold the electrical box cover in place and remove the cover.
3. Remove the two bolts that secure the front cover in place.
4. Loosen the four bolts that hold the fan guard in place.
5. Swing the front cover open.



6. For the fan signal cable: remove the **YELLOW** wire from the **PWM** terminal and remove the **BLACK** wire from the **GND** terminal.
7. For the fan power cable: remove the **BLUE** wire from **L1**, the **RED** wire from **L2** and the **YELLOW/GREEN** wire from **GND**.
8. Pull the cables out of the electrical box, noting the path for installation of the new fan. Cut wire ties if necessary.
9. Remove the four fan guard bolts and remove the fan and guard as one.
10. Installation is the reverse of removal.

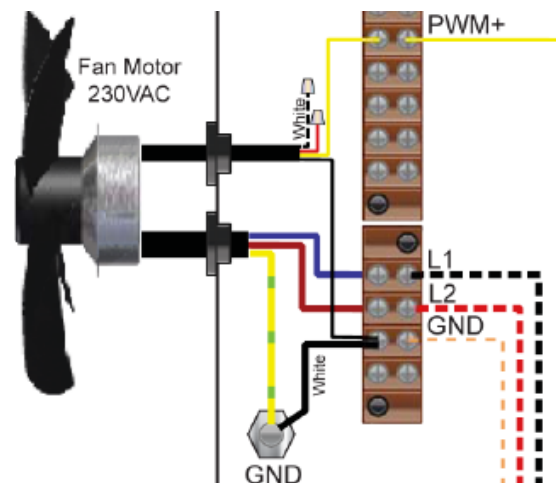

## Control Board Replacement Procedure

1. Turn the power off to the unit.
2. Take a picture of the control board and connectors for reference. The picture in [Appendix A](#) may also be helpful.
3. Carefully remove all green terminal strips on the left side, the right side and the bottom of the control board. They pull straight off the board, with no need to disconnect wires from their screw terminals. You may need to wiggle them from both ends for the 8 pin ones.
4. Remove the red six pin display board connector from the left side of the control board (marked DISPLAY on the board).

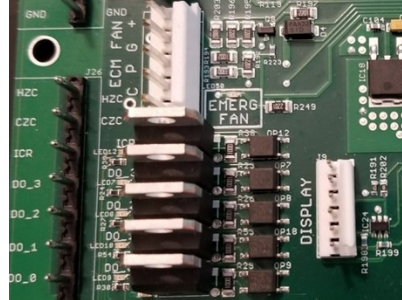
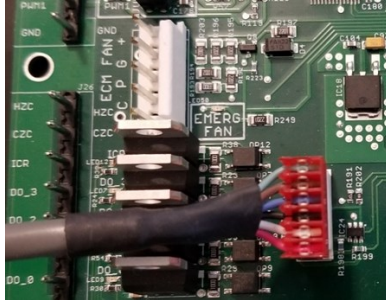

5. Remove all connectors from the top of the control board. Each connector (or wire) should be marked already from the factory, e.g. HPS1, LP1, TS1, etc.. This matches the marking on the control board.
6. The control board is held in place at its four corners. Squeeze each standoff by hand or with needle nose pliers if necessary and carefully pull the corner of the board off of the standoff.
7. Once the control board has been removed, if there are any other standoffs left (they have the bottom snap cut off) remove them as well.
8. Carefully remove the new control board from the static bag it was shipped in. Place any cut off standoffs from the old board into the same locations on the new board.
9. Align the control board with the four corner standoffs in the electrical box then push on each corner until they snap in place.
10. Connect the top connectors to the control board. Refer to the **Step 2** picture if necessary for proper locations.  
Note that the connector with the resistor (no cable) goes on **CTS**.  
Note that the connector to the left of **CTS** is marked **HTS** on older boards, and **ODTS** on newer boards.
11. Check each of the connectors from Step 10 to ensure they are properly aligned and that no pins are showing.
12. Connect the green terminal strips to the left side, right side and bottom of the control board. Refer to the **Step 2** picture if necessary for locations.
13. Turn the power on to the unit. Ensure the LCD display comes on. Note the firmware version. After EEV zeroing and Random Start countdown the display should begin alternating data.
14. If the replacement control board was pre-configured for this unit at the factory then the system is ready for operation. If it was not then use the PC App corresponding to the unit's firmware version to configure the unit. Refer to the **Tools -> Configuration** menu in the [PC APP](#) section.

## LCD Interface (Display) Board Replacement Procedure

1. Turn the power off to the unit.
2. Remove the display board cable connector from the control board.

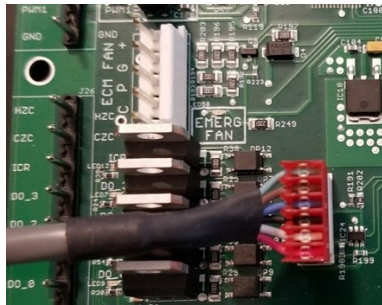

3. Using a sharp utility knife with a long blade, slice each of the display board standoff heads off, taking care to not damage the lexan cover.

4. Pull the display board from the unit.
5. Remove the display board cable connector from the back of the display board.
6. Place a new display board standoff into each of the four holes in the cabinet.
7. Remove the new display board from the static bag it was shipped in.
8. Connect one end of the display board cable to the back of the display board. Ensure the connector is properly aligned and that no pins are showing.
9. Place the display board in position and align the four standoffs into the four holes of the board.
10. Push on each corner of the board until each standoff snaps in place, while pushing on the front of the standoff to keep it from popping out of the cabinet hole.
11. Connect the other end of the display board cable to the control board, ensuring the connector is aligned properly and that no pins are showing.
12. Turn the power on to the unit and verify the display works.
13. Once the display begins to scroll data, test each of the buttons to ensure they work. Push the Arrow button to enter the Main Menu, then use the Up and Down to move through the list, then push the OK button to exit again. If any of the buttons seem hard to press, repeat Step 10 and then test the buttons again.

## Air Thermostat Sensor Replacement Procedure

1. Turn the power off to the PC unit.
2. Remove air thermostat from the wall, and remove the back by loosening two screws with a 1/16" hex key.
3. Wiggle the sensor and pull to the right to remove it.
4. Install a replacement sensor (available from Maritime Geothermal Ltd.) by plugging it in where the old one was.
5. Re-install the thermostat.

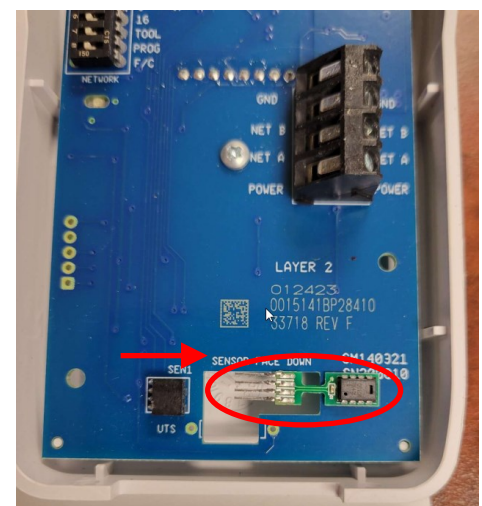

# Model Specific Information

**Table 28 - Shipping Information (PC)**

MODEL	WEIGHT lb. (kg)	DIMENSIONS in (cm)		
		L	W	H
PC-45	515 (234)	70 (178)	44 (112)	40 (102)
PC-55	520 (236)	70 (178)	44 (112)	40 (102)
PC-65	550 (250)	70 (178)	44 (112)	40 (102)
PC-75	610 (277)	70 (178)	44 (112)	40 (102)
PC-80	610 (277)	70 (178)	44 (112)	40 (102)

**Table 29 - Shipping Information (AC2 Outdoor Unit)**

MODEL	WEIGHT lb. (kg)	DIMENSIONS in (cm)		
		L	W	H
AC2-45	230 (104)	36 (91)	70 (178)	45 (114)
AC2-55	230 (104)	36 (91)	70 (178)	45 (114)
AC2-65	295 (134)	36 (91)	70 (178)	56 (142)
AC2-75	295 (134)	36 (91)	70 (178)	56 (142)
AC2-80	295 (134)	36 (91)	70 (178)	56 (142)

**Table 30 - Refrigerant Charge**

MODEL	lb	kg	Refrigerant	Oil Type
PC-45	9.0	4.1	R454b	POE
PC-55	10.0	4.5	R454b	POE
PC-65	11.0	5.0	R454b	POE
PC-75	12.0	5.4	R454b	POE
PC-80	12.0	5.4	R454b	POE

- Oil capacity is marked on the compressor label.  
- **Refrigerant charge is subject to revision**; actual charge is indicated on the unit nameplate.

**Table 31 - Control Temperature Limits**

Parameter	Device	MIN.	MAX.
Room Relative Humidity (RH)	Room Thermostat or BACnet	30%	80%
Room Air Temperature	Room Thermostat or BACnet	60°F (16°C)	95°F (35°C)
Pool Water Temperature ( <i>PC-T only</i> )	Internal Setpoint Control or optional aquastat or BACnet	70°F (21°C)	108°F (42°C)

**Table 32 - AC2-Series Outdoor Unit Sound Levels (dBA)\***

MODEL	1 ft distance		3 ft distance		5 ft distance		10 ft distance	
	Front	Side	Front	Sides	Front	Sides	Front	Sides
AC2-45	68.0	61.1	66.4	59.7	63.5	57.4	59.3	56.7
AC2-55	72.4	66.8	71.1	64.8	68.0	62.9	64.6	61.1
AC2-65	70.3	62.9	65.9	60.5	62.2	58.1	56.6	54.0
AC2-75	71.7	66.8	68.7	63.7	65.7	61.2	60.0	57.1
AC2-80	71.7	66.8	68.7	63.7	65.7	61.2	60.0	57.1

\* At maximum fan speed. This occurs in heating mode, or in cooling mode with outdoor greater than ~27°C.

# Capacity Ratings

TABLE 33 - PC-Series Capacity Ratings (60Hz)									
Model	Pool Flow <i>(PC-T only)</i>		Airflow	Input Energy	Cooling Capacity	Heat Rejection (Pool, Room Air, or Outdoor Unit)	Moisture Removal @ 50%RH	Moisture Removal @ 60%RH	Typical Pool Surface Area
	gpm	L/s	cfm (L/s)	Watts	Btu/hr (kW)	Btu/hr (kW)	lb(kg) / hr	lb(kg) / hr	ft <sup>2</sup> (m <sup>2</sup> )
<b>PC-45</b>	21	1.3	1150 (540)	2020	46,000 (13.5)	53,000 (15.5)	14 (6.4)	18 (8.2)	600 (56)
<b>PC-55</b>	28	1.8	1500 (710)	3000	64,000 (18.8)	74,400 (21.8)	19 (8.6)	23 (10)	800 (74)
<b>PC-65</b>	35	2.2	1900 (900)	4050	77,000 (22.6)	90,900 (26.7)	24 (11)	30 (14)	1050 (98)
<b>PC-75</b>	40	2.5	2200 (1040)	4570	87,000 (25.5)	102,600 (30.1)	28 (13)	33 (15)	1200 (110)
<b>PC-80</b>	45	2.8	2300 (1085)	5790	103,300 (30.3)	123,100 (36.1)	32 (14)	38 (17)	1350 (130)

\*EWT (Tp)=80°F (26.7°C) and EAT (Ta)=82°F (27.8°C)

# Cooling Mode Performance Tables (Heat Rejection to AC2 Outdoor Unit)

## PC-45 with AC2-45 R454b, 60 Hz

COOLING	OUTDOOR LOOP (Air)			ELECTRICAL			INDOOR LOOP (Air @ 50% RH)								
	Outdoor Air Temperature	Condensing Temperature	Heat Rejected (Btu/hr)	Compressor Current (A)	Fan (W)	Input Power (W)	EAT	Evap. Temp.	Airflow (cfm)	LAT (°F)	Delta T (°F)	Latent (Btu/hr)	Sensible (Btu/hr)	Cooling (Btu/hr)	EER
	50°F	61	47,054	6.4	170	1,739	80°F	46	1,150	56	24	12,370	28,455	<b>40,825</b>	<b>23.5</b>
	60°F	71	45,268	6.8	170	1,852		47	1,150	150	23	11,712	26,941	<b>38,653</b>	<b>20.9</b>
	70°F	82	43,764	7.5	170	2,018		47	1,150	59	21	11,085	25,499	<b>36,583</b>	<b>18.1</b>
	80°F	92	42,248	8.3	170	2,191		47	1,150	60	20	10,446	24,030	<b>34,476</b>	<b>15.7</b>
	90°F	103	41,028	9.4	170	2,456		48	1,150	61	19	9,679	22,691	<b>32,370</b>	<b>13.2</b>
	100°F	113	39,667	10.6	170	2,703		48	1,150	62	18	9,020	21,147	<b>30,167</b>	<b>11.2</b>
	110°F	124	38,322	12.2	170	2,993		49	1,150	64	16	8,322	19,510	<b>27,832</b>	<b>9.3</b>
	120°F	135	36,960	14.1	170	3,319		49	1,150	65	15	7,581	17,774	<b>25,356</b>	<b>7.6</b>

METRIC

COOLING	OUTDOOR LOOP (Air)			ELECTRICAL			INDOOR LOOP (Air @ 50% RH)								
	Outdoor Air Temperature	Condensing Temperature	Heat Rejected (W)	Compressor Current (A)	Fan (W)	Input Power (W)	EAT	Evap. Temp.	Airflow (L/s)	LAT (°C)	Delta T (°C)	Latent (W)	Sensible (W)	Cooling (W)	COP <sub>c</sub>
	10°C	16.1	13,787	6.4	170	1,739	27°C	7.9	540	13.5	13.2	3,624	8,337	<b>11,962</b>	<b>6.88</b>
	16°C	21.7	13,263	6.8	170	1,852		8.1	540	14.2	12.5	3,432	7,894	<b>11,325</b>	<b>6.11</b>
	21°C	27.8	12,823	7.5	170	2,018		8.3	540	14.9	11.8	3,248	7,471	<b>10,719</b>	<b>5.31</b>
	27°C	33.3	12,379	8.3	170	2,191		8.6	540	15.5	11.1	3,061	7,041	<b>10,101</b>	<b>4.61</b>
	32°C	39.4	12,021	9.4	170	2,456		8.8	540	16.2	10.5	2,836	6,649	<b>9,484</b>	<b>3.86</b>
	38°C	45.0	11,622	10.6	170	2,703		9.0	540	16.9	9.8	2,643	6,196	<b>8,839</b>	<b>3.27</b>
	43°C	51.1	11,228	12.2	170	2,993		9.2	540	17.6	9.0	2,438	5,716	<b>8,155</b>	<b>2.72</b>
	49°C	57.2	10,829	14.1	170	3,319		9.4	540	18.4	8.2	2,221	5,208	<b>7,429</b>	<b>2.24</b>

## PC-55 with AC2-55 R454b, 60 Hz

COOLING	OUTDOOR LOOP (Air)			ELECTRICAL			INDOOR LOOP (Air @ 50% RH)								
	Outdoor Air Temperature	Condensing Temperature	Heat Rejected (Btu/hr)	Compressor Current (A)	Fan (W)	Input Power (W)	EAT	Evap. Temp.	Airflow (cfm)	LAT (°F)	Delta T (°F)	Latent (Btu/hr)	Sensible (Btu/hr)	Cooling (Btu/hr)	EER
	50°F	62	58,709	8.7	195	2,164	80°F	46	1,500	56	24	15,432	35,499	<b>50,931</b>	<b>23.5</b>
	60°F	72	57,478	9.4	195	2,367		46	1,500	57	23	14,849	34,157	<b>49,006</b>	<b>20.7</b>
	70°F	83	56,122	10.5	195	2,613		46	1,500	58	22	14,184	32,627	<b>46,811</b>	<b>17.9</b>
	80°F	93	54,638	11.8	195	2,853		47	1,500	59	21	13,486	31,022	<b>44,508</b>	<b>15.6</b>
	90°F	104	53,224	13.4	195	3,194		47	1,500	60	20	12,535	29,388	<b>41,923</b>	<b>13.1</b>
	100°F	114	51,622	15.0	195	3,538		48	1,500	62	18	11,705	27,442	<b>39,146</b>	<b>11.1</b>
	110°F	125	50,123	17.2	195	3,968		48	1,500	63	17	10,818	25,362	<b>36,180</b>	<b>9.1</b>
	120°F	135	48,394	19.4	195	4,383		48	1,500	65	15	9,878	23,159	<b>33,037</b>	<b>7.5</b>

METRIC

COOLING	OUTDOOR LOOP (Air)			ELECTRICAL			INDOOR LOOP (Air @ 50% RH)								
	Outdoor Air Temperature	Condensing Temperature	Heat Rejected (W)	Compressor Current (A)	Fan (W)	Input Power (W)	EAT	Evap. Temp.	Airflow (L/s)	LAT (°C)	Delta T (°C)	Latent (W)	Sensible (W)	Cooling (W)	COP <sub>c</sub>
	10°C	16.7	17,202	8.7	195	2,164	27°C	7.6	700	13.5	13.1	4,522	10,401	<b>14,923</b>	<b>6.90</b>
	16°C	22.2	16,841	9.4	195	2,367		7.8	700	14.0	12.7	4,351	10,008	<b>14,359</b>	<b>6.07</b>
	21°C	28.3	16,444	10.5	195	2,613		8.0	700	14.6	12.1	4,156	9,560	<b>13,715</b>	<b>5.25</b>
	27°C	33.9	16,009	11.8	195	2,853		8.2	700	15.2	11.5	3,951	9,089	<b>13,041</b>	<b>4.57</b>
	32°C	40.0	15,594	13.4	195	3,194		8.4	700	15.8	10.9	3,673	8,611	<b>12,283</b>	<b>3.85</b>
	38°C	45.6	15,125	15.0	195	3,538		8.7	700	16.5	10.2	3,429	8,040	<b>11,470</b>	<b>3.24</b>
	43°C	51.7	14,686	17.2	195	3,968		8.9	700	17.3	9.4	3,170	7,431	<b>10,601</b>	<b>2.67</b>
	49°C	57.2	14,179	19.4	195	4,383		9.1	700	18.1	8.6	2,894	6,785	<b>9,680</b>	<b>2.21</b>

# Cooling Mode Performance Tables (Heat Rejection to AC2 Outdoor Unit)

## PC-65 with AC2-65 R454b, 60 Hz

	OUTDOOR LOOP (Air)			ELECTRICAL			INDOOR LOOP (Air @ 50% RH)								
	Outdoor Air Temperature	Condensing Temperature	Heat Rejected (Btu/hr)	Compressor Current (A)	Fan (W)	Input Power (W)	EAT	Evap. Temp.	Airflow (cfm)	LAT (°F)	Delta T (°F)	Latent (Btu/hr)	Sensible (Btu/hr)	Cooling (Btu/hr)	EER
<b>COOLING</b>	50°F	62	75,605	11.5	325	2,827	80°F	46	1,900	56	24	19,831	45,618	<b>65,449</b>	<b>23.2</b>
	60°F	72	73,150	12.3	325	3,038		46	1,900	57	23	18,869	43,404	<b>62,272</b>	<b>20.5</b>
	70°F	83	71,046	13.5	325	3,339		46	1,900	58	22	17,920	41,222	<b>59,142</b>	<b>17.7</b>
	80°F	93	68,938	14.9	325	3,640		47	1,900	60	21	16,970	39,037	<b>56,008</b>	<b>15.4</b>
	90°F	104	67,066	16.8	325	4,050		47	1,900	61	20	15,773	36,980	<b>52,753</b>	<b>13.0</b>
	100°F	114	65,053	18.8	325	4,469		48	1,900	62	18	14,743	34,566	<b>49,309</b>	<b>11.0</b>
	110°F	125	63,253	21.4	325	5,009		48	1,900	63	17	13,654	32,011	<b>45,664</b>	<b>9.1</b>
	120°F	135	61,121	24.1	325	5,549		48	1,900	65	15	12,465	29,225	<b>41,690</b>	<b>7.5</b>

METRIC

	OUTDOOR LOOP (Air)			ELECTRICAL			INDOOR LOOP (Air @ 50% RH)								
	Outdoor Air Temperature	Condensing Temperature	Heat Rejected (W)	Compressor Current (A)	Fan (W)	Input Power (W)	EAT	Evap. Temp.	Airflow (L/s)	LAT (°C)	Delta T (°C)	Latent (W)	Sensible (W)	Cooling (W)	COP <sub>c</sub>
<b>COOLING</b>	10°C	16.7	22,152	11.5	325	2,827	27°C	7.6	900	13.3	13.3	5,810	13,366	<b>19,176</b>	<b>6.78</b>
	16°C	22.2	21,433	12.3	325	3,038		7.8	900	14.0	12.7	5,528	12,717	<b>18,246</b>	<b>6.01</b>
	21°C	28.3	20,816	13.5	325	3,339		8.0	900	14.6	12.1	5,251	12,078	<b>17,328</b>	<b>5.19</b>
	27°C	33.9	20,199	14.9	325	3,640		8.2	900	15.3	11.4	4,972	11,438	<b>16,410</b>	<b>4.51</b>
	32°C	40.0	19,650	16.8	325	4,050		8.4	900	15.9	10.8	4,622	10,835	<b>15,457</b>	<b>3.82</b>
	38°C	45.6	19,060	18.8	325	4,469		8.7	900	16.6	10.1	4,320	10,128	<b>14,447</b>	<b>3.23</b>
	43°C	51.7	18,533	21.4	325	5,009		8.9	900	17.3	9.4	4,000	9,379	<b>13,379</b>	<b>2.67</b>
	49°C	57.2	17,908	24.1	325	5,549		9.1	900	18.1	8.5	3,652	8,563	<b>12,215</b>	<b>2.20</b>

## PC-75 with AC2-75 R454b, 60 Hz

	OUTDOOR LOOP (Air)			ELECTRICAL			INDOOR LOOP (Air @ 50% RH)								
	Outdoor Air Temperature	Condensing Temperature	Heat Rejected (Btu/hr)	Compressor Current (A)	Fan (W)	Input Power (W)	EAT	Evap. Temp.	Airflow (cfm)	LAT (°F)	Delta T (°F)	Latent (Btu/hr)	Sensible (Btu/hr)	Cooling (Btu/hr)	EER
<b>COOLING</b>	50°F	63	88,261	14.0	450	3,311	80°F	46	2,200	55	25	23,167	53,291	<b>76,458</b>	<b>23.1</b>
	60°F	73	85,697	15.5	450	3,593		46	2,200	56	24	22,098	50,834	<b>72,932</b>	<b>20.3</b>
	70°F	83	83,316	17.0	450	3,984		46	2,200	57	23	20,973	48,244	<b>69,217</b>	<b>17.4</b>
	80°F	93	80,444	18.7	450	4,290		47	2,200	58	22	19,786	45,514	<b>65,300</b>	<b>15.2</b>
	90°F	104	77,778	20.8	450	4,733		47	2,200	60	20	18,261	42,813	<b>61,074</b>	<b>12.9</b>
	100°F	114	74,910	23.0	450	5,194		47	2,200	61	19	16,933	39,699	<b>56,632</b>	<b>10.9</b>
	110°F	124	72,324	25.6	450	5,801		47	2,200	63	17	15,541	36,435	<b>51,976</b>	<b>9.0</b>
	120°F	134	69,726	28.6	450	6,447		47	2,200	64	16	14,105	33,068	<b>47,173</b>	<b>7.3</b>

METRIC

	OUTDOOR LOOP (Air)			ELECTRICAL			INDOOR LOOP (Air @ 50% RH)								
	Outdoor Air Temperature	Condensing Temperature	Heat Rejected (W)	Compressor Current (A)	Fan (W)	Input Power (W)	EAT	Evap. Temp.	Airflow (L/s)	LAT (°C)	Delta T (°C)	Latent (W)	Sensible (W)	Cooling (W)	COP <sub>c</sub>
<b>COOLING</b>	10°C	17.2	25,860	14.0	450	3,311	27°C	7.8	1,040	12.6	14.1	6,788	15,614	<b>22,402</b>	<b>6.77</b>
	16°C	22.8	25,109	15.5	450	3,593		7.9	1,040	13.2	13.4	6,475	14,894	<b>21,369</b>	<b>5.95</b>
	21°C	28.3	24,411	17.0	450	3,984		8.0	1,040	13.9	12.8	6,145	14,135	<b>20,280</b>	<b>5.09</b>
	27°C	33.9	23,570	18.7	450	4,290		8.1	1,040	14.6	12.0	5,797	13,336	<b>19,133</b>	<b>4.46</b>
	32°C	40.0	22,789	20.8	450	4,733		8.2	1,040	15.3	11.3	5,350	12,544	<b>17,895</b>	<b>3.78</b>
	38°C	45.6	21,948	23.0	450	5,194		8.3	1,040	16.2	10.5	4,961	11,632	<b>16,593</b>	<b>3.19</b>
	43°C	51.1	21,191	25.6	450	5,801		8.4	1,040	17.0	9.6	4,553	10,675	<b>15,229</b>	<b>2.63</b>
	49°C	56.7	20,430	28.6	450	6,447		8.6	1,040	17.9	8.7	4,133	9,689	<b>13,822</b>	<b>2.14</b>

go to TABLE OF CONTENTS



# Cooling Mode Performance Tables (Heat Rejection to AC2 Outdoor Unit)

PC-80 with AC2-80 R454b, 60 Hz

	OUTDOOR LOOP (Air)			ELECTRICAL			INDOOR LOOP (Air @ 50% RH)								
	Outdoor Air Temperature	Condensing Temperature	Heat Rejected (Btu/hr)	Compressor Current (A)	Fan (W)	Input Power (W)	EAT	Evap. Temp.	Airflow (cfm)	LAT (°F)	Delta T (°F)	Latent (Btu/hr)	Sensible (Btu/hr)	Cooling (Btu/hr)	EER
<b>COOLING</b>	50°F	63	104,148	16.5	450	3,907	<b>80°F</b>	45	2,300	51	30	27,360	62,937	<b>90,297</b>	<b>23.1</b>
	60°F	73	101,294	18.3	450	4,247		45	2,300	52	28	26,076	59,984	<b>86,060</b>	<b>20.3</b>
	70°F	83	98,313	20.1	450	4,701		45	2,300	53	27	24,759	56,952	<b>81,711</b>	<b>17.4</b>
	80°F	93	95,004	22.1	450	5,066		45	2,300	54	26	23,347	53,707	<b>77,054</b>	<b>15.2</b>
	90°F	104	91,934	24.6	450	5,594		46	2,300	56	24	21,566	50,562	<b>72,128</b>	<b>12.9</b>
	100°F	114	88,431	27.2	450	6,132		46	2,300	58	22	19,988	46,861	<b>66,848</b>	<b>10.9</b>
	110°F	124	85,342	30.2	450	6,845		46	2,300	60	20	18,354	43,030	<b>61,384</b>	<b>9.0</b>
	120°F	134	82,325	33.8	450	7,612		46	2,300	61	19	16,644	39,020	<b>55,664</b>	<b>7.3</b>

METRIC

	OUTDOOR LOOP (Air)			ELECTRICAL			INDOOR LOOP (Air @ 50% RH)								
	Outdoor Air Temperature	Condensing Temperature	Heat Rejected (W)	Compressor Current (A)	Fan (W)	Input Power (W)	EAT	Evap. Temp.	Airflow (L/s)	LAT (°C)	Delta T (°C)	Latent (W)	Sensible (W)	Cooling (W)	COP <sub>c</sub>
<b>COOLING</b>	10°C	17.2	30,515	16.5	450	3,907	<b>27°C</b>	7.2	1090	10.4	16.6	8,017	18,440	<b>26,457</b>	<b>6.77</b>
	16°C	22.8	29,679	18.3	450	4,247		7.3	1090	11.2	15.8	7,641	17,575	<b>25,215</b>	<b>5.94</b>
	21°C	28.3	28,805	20.1	450	4,701		7.4	1090	11.9	15.1	7,254	16,686	<b>23,941</b>	<b>5.09</b>
	27°C	33.9	27,836	22.1	450	5,066		7.5	1090	12.8	14.2	6,840	15,736	<b>22,577</b>	<b>4.46</b>
	32°C	40.0	26,937	24.6	450	5,594		7.6	1090	13.6	13.4	6,318	14,814	<b>21,134</b>	<b>3.78</b>
	38°C	45.6	25,910	27.2	450	6,132		7.7	1090	14.6	12.4	5,856	13,730	<b>19,586</b>	<b>3.19</b>
	43°C	51.1	25,005	30.2	450	6,845		7.8	1090	15.7	11.3	5,377	12,607	<b>17,985</b>	<b>2.63</b>
	49°C	56.7	24,122	33.8	450	7,612		8.1	1090	16.7	10.3	4,877	11,433	<b>16,310</b>	<b>2.14</b>

# Water Flow & Pressure Drop Data

MODEL	POOL WATER FLOW		OPTIONAL GROUND LOOP HEAT REJECTION WATER COIL			
	gpm	L/s	MGL P/N	COIL	gpm	L/s
PC-45	21	1.3	03-7001	BTSSC-60	10	0.63
PC-55	28	1.8	03-7019	BTSSC-72	12	0.76
PC-65	35	2.2			14	0.88
PC-75	40	2.5	03-7040	BTSSC-84	16	1.0
PC-80	45	2.8			17	1.1

Maximum operating pressure for pool water loop is **25 psi**.

Flow (gpm)	psi	kPa
20	1.5	10
25	2.2	15
30	2.9	20
35	3.8	26
40	4.7	32
45	5.8	40
50	6.9	48
60	9.5	66

PC-45 →  
 PC-55 →  
 PC-65 →  
 PC-75 →  
 PC-80 →

Table 37: Pressure Drop for Optional Ground Loop Heat Rejection Coil

			Water 104°F		Water 50°F		15% Methanol 32°F		35% prop. glycol 32°F	
	gpm	L/s	psi	kPa	psi	kPa	psi	kPa	psi	kPa
PC-45 (coil 03-7001)	6	0.38	1.6	11	1.7	12	2.0	14	2.6	18
	7	0.44	1.9	13	2.1	14	2.5	17	3.3	23
	8	0.50	2.6	18	2.8	19	3.0	21	4.0	27
	9	0.57	3.2	22	3.5	24	3.8	26	5.0	34
	10	0.63	3.8	26	4.0	28	4.7	32	6.2	43
	11	0.69	4.3	30	4.6	32	5.5	38	7.2	50
	12	0.76	5.2	36	5.5	38	6.6	45	8.7	60
	13	0.82	5.9	41	6.2	43	7.4	51	9.7	67
PC-55 PC-65 (coil 03-7019)	8	0.50	1.8	12	1.9	13	2.1	14	2.8	19
	9	0.57	2.2	15	2.4	17	2.4	17	3.2	22
	10	0.63	2.7	19	2.9	20	3.1	21	4.1	28
	11	0.69	2.8	19	3.1	21	3.6	25	4.7	33
	12	0.76	3.4	23	3.7	26	4.4	30	5.8	40
	13	0.82	4	28	4.3	30	5	34	6.6	45
	14	0.88	4.7	32	5	34	5.7	39	7.5	52
	15	0.95	5.6	39	5.8	40	6.4	44	8.4	58
PC-75 PC-80 (coil 03-7040)	11	0.69	2.9	20	3.2	22	4	28	5.3	36
	12	0.76	3.6	25	3.9	27	4.6	32	6.0	42
	13	0.82	4.1	28	4.4	30	5.2	36	6.8	47
	14	0.88	4.7	32	5	34	5.8	40	7.6	53
	15	0.95	5.5	38	5.7	39	6.5	45	8.5	59
	16	1.01	6.3	43	6.5	45	7.3	50	9.6	66
	17	1.07	7.1	49	7.3	50	8.1	56	10.7	74

NOTE: these pressure drops include a 3.5 ft of connecting 1" copper piping and four 1" copper elbows .

# Electrical Specifications

TABLE 38 - PC-Series (R454b) Electrical Data										
	Elec. Code	Power Supply			Compressor		FLA	MCA	Maximum Fuse/Breaker	Minimum Wire Size
		V- $\phi$ -Hz	MIN	MAX	RLA	LRA	Amps	Amps	Amps	ga
PC-45	1	208/230-1-60	187	253	16.7	94	20.4	24.6	40	#8-2
	2	208-3-60	187	229	12.2	98	15.9	19.0	30	#10-3
	4	460-3-60	414	506	5.8	44	9.5	11.0	15	#14-3
PC-55	1	208/230-1-60	187	253	22.4	126	26.6	32.2	50	#8-2
	2	208-3-60	187	229	12.8	120	17.0	20.2	30	#10-3
	4	460-3-60	414	506	6.0	49	10.2	11.7	20	#12-3
PC-65	1	208/230-1-60	187	253	25.6	155	31.3	37.7	60	#6-2
	2	208-3-60	187	229	18.6	155	24.3	29.0	40	#8-3
	4	460-3-60	414	506	8.3	58	14.0	16.1	20	#12-3
PC-75	1	208/230-1-60	187	253	30.1	170	36.8	44.3	60	#6-2
	2	208-3-60	187	229	21.2	157	27.9	33.2	50	#8-3
	4	460-3-60	414	506	9.1	75	15.8	18.1	30	#10-3
PC-80	1	208/230-1-60	187	253	32.8	184	40.0	48.2	80	#4-2
	2	208-3-60	187	229	22.4	166	29.6	35.2	50	#8-3
	4	460-3-60	414	506	8.8	75	16.0	18.2	30	#10-3

TABLE 39 - Plenum Heater Electrical Data										
Size (kW)	(230-1-60)					(208-1-60)				
	Actual (kW)	FLA (A)	MCA (A)	Breaker (A)	Wire Size	Actual (kW)	FLA (A)	MCA (A)	Breaker (A)	Wire Size
5	5	20.8	26.0	30	#10	3.8	18.1	22.6	30	#10
7	7	29.2	36.5	40	#8	5.3	25.3	31.6	40	#8
10	10	41.7	52.1	60	#6	7.5	36.1	45.1	50	#6
15	15	62.5	78.1	80	#4	11.3	54.2	67.7	80	#4
20	20	83.3	104.2	100	#3	15.0	72.2	90.3	100	#3

# Indoor Airflow

TABLE 40 - Indoor Airflow												
Model Size	Nominal		Range		Airflow Reduction* - 20%		Airflow Reduction* - 15%		Airflow Reduction* - 10%		Airflow Reduction* - 5%	
	cfm	L/s	cfm	L/s	cfm	L/s	cfm	L/s	cfm	L/s	cfm	L/s
45	1150	540	900-1400	430-660	920	430	980	460	1040	490	1090	520
55	1500	710	1200-1800	570-850	1200	570	1280	600	1350	640	1430	670
65	1900	900	1500-2300	710-1090	1520	720	1620	760	1710	810	1810	850
75	2200	1040	1750-2500	830-1180	1760	830	1870	880	1980	940	2090	990
80	2300	1085	1850-2500	873-1180	1840	870	1955	920	2070	980	2185	1030

TABLE 41 - Indoor Airflow for Auxiliary Air Heat												
Model Size	Nominal		Range		Airflow Reduction* - 20%		Airflow Reduction* - 15%		Airflow Reduction* - 10%		Airflow Reduction* - 5%	
	cfm	L/s	cfm	L/s	cfm	L/s	cfm	L/s	cfm	L/s	cfm	L/s
45	1150	540	900-1400	430-660	920	430	980	460	1040	490	1090	520
55	1500	710	1200-1800	570-850	1200	570	1280	600	1350	640	1430	670
65	1900	900	1700-2300	800-1090	1520	720	1620	760	1710	810	1810	850
75	2200	1040	2000-2500	940-1180	1760	830	1870	880	1980	940	2090	990
80	2300	1085	2100-2500	991-1180	1840	870	1955	920	2070	980	2185	1030

TABLE 42 - Indoor Airflow for Air Recirculation Only** (activated by R—G switch, jumper, or dry contact)												
Model Size	Nominal		Range		Airflow Reduction* - 20%		Airflow Reduction* - 15%		Airflow Reduction* - 10%		Airflow Reduction* - 5%	
	cfm	L/s	cfm	L/s	cfm	L/s	cfm	L/s	cfm	L/s	cfm	L/s
45	650	310	500-800	240-380	520	250	550	260	590	280	620	290
55	850	400	700-1000	330-470	680	320	720	340	770	360	810	380
65	1100	520	900-1300	430-610	880	420	940	440	990	470	1050	490
75	1250	590	1000-1500	470-710	1000	470	1060	500	1130	530	1190	560
80	1300	615	1050-1550	496-732	1040	490	1105	520	1170	550	1235	585

**Maximum external static pressure:**  
0.50in H<sub>2</sub>O

\*To obtain the airflow reduction (AR) values, use a dry contact to connect AR to 24VAC on the right side of control board. Airflow reduction % is set through PC App.

\*\*Air recirculation (airflow even when PC unit is idle with no other demand active) is activated by making a connection with switch, jumper, or dry contact from **R** to **G** at lower right of control board.

# PC-Series Schematic Diagram 208/230-1-60

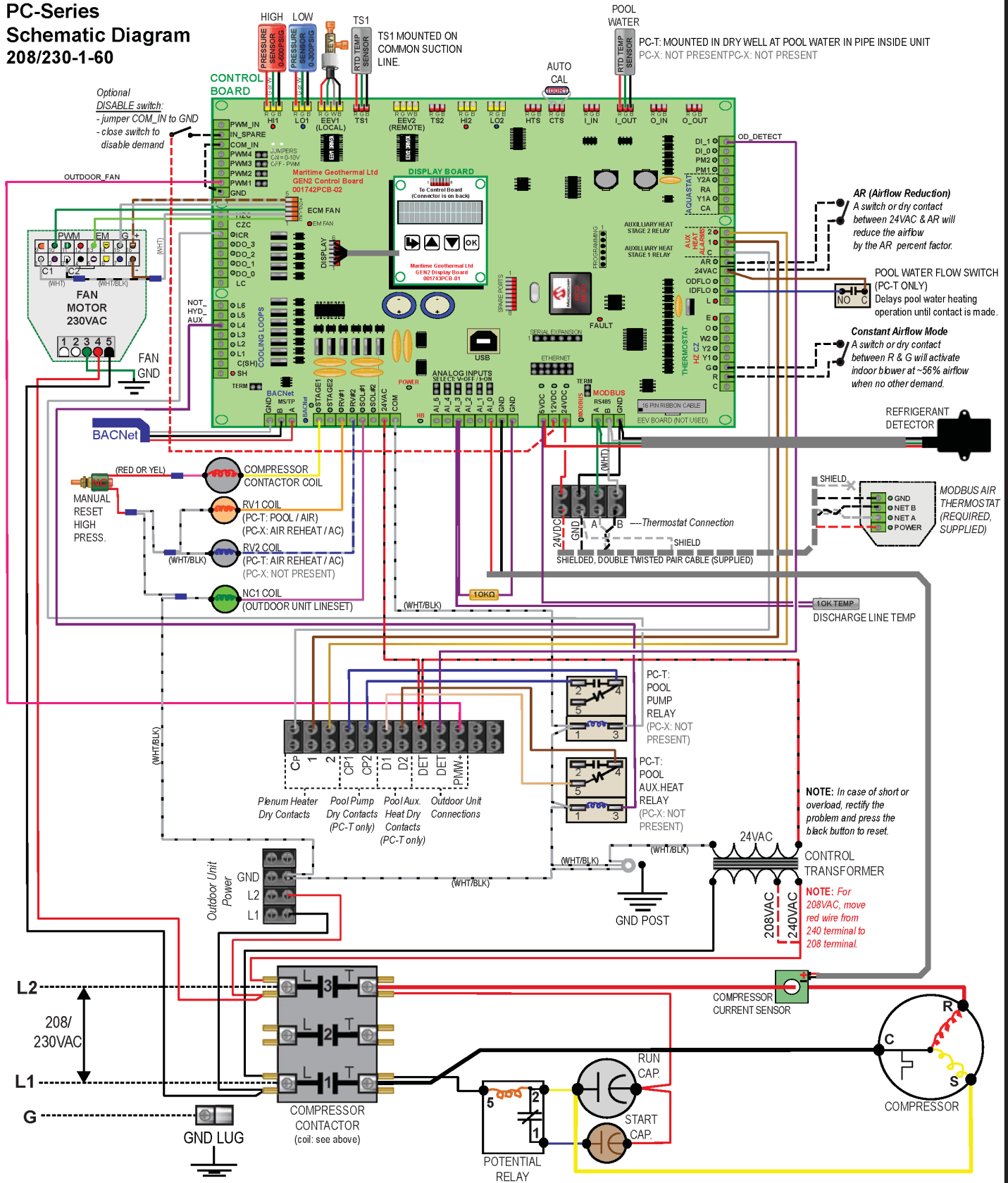

01	000326 (1R)	D. RHEAULT	D. RHEAULT	2-Oct-2024	Drawn By <b>D. RHEAULT</b> Date 2-Oct-2024 Checked By <b>D. RHEAULT</b> Date 2-Oct-2024 Eng. Approved By Date Mfg. Approved By Date Approved By Date	Date 2-Oct-2024 Date 2-Oct-2024 Date Date Date	<b>MARITIME GEOTHERMAL LTD.</b> P.O. Box 2555 170 Plantation Rd. Pettitcodiac, NB CANADA E4Z 6H4	Drawing Name <b>PC-** X-1S-T/X-KDER*</b> Schematic Diagram	Size LET	Drawing Number 002754SCH	Drawing Rev 01	Sheet 1 / 1
REV	ECO#	IMPL BY	APVD BY	DATE								

go to TABLE OF CONTENTS

# PC-Series Electrical Box Diagram 208/230-1-60

## AIR THERMOSTAT (REQUIRED)

Connect the communicating thermostat to the terminal strip with supplied shielded, double twisted pair cable:

- A - communication: use **one twisted pair**
- B - power: use **other twisted pair**
- 24VDC - power: use **other twisted pair**
- GND - Ground

## CONSTANT AIRFLOW MODE

A switch or dry contact between R & G will activate the indoor blower at ~56% airflow when no other demand. R - 24VAC G - blower activation

## BACNet CONNECTIONS (MS/TP RS-485)

Use a shielded, twisted pair cable to connect the optional BACNet connections to the control board.

- A - communication: use **one twisted pair**
- B - Ground

BACNet Object	Activation
SYSTEM_G	Constant Airflow/Fan Recirculation Mode
SYSTEM_Y1	Air Reheat/Aux. Heat or Air Cool Demand
SYSTEM_O	Air Heating (OFF) / Air Cooling (ON)
SYSTEM_Y1A	Pool Water Heat Demand
SYSTEM_DH	Air Dehumidify Demand

## PLENUM HEATER DRY CONTACTS

Use an 18-3 cable to connect the air plenum heater control board to the pool conditioner terminal strip: CP - 24VAC from plenum heater

- 1 - dry contact, closed on call for electric heat stage 1
- 2 - dry contact, closed on call for electric heat stage 2

## POOL PUMP DRY CONTACTS (PC-X: N/A)

If pool pump control is required, use an 18-2 cable to relay a 24VAC signal to activate an external contactor: CP1 - dry contacts, closed on call for pool water flow CP2 - dry contacts, closed on call for pool water flow

## POOL AUXILIARY HEAT DRY CONTACTS (PC-X: N/A)

If an auxiliary pool heating device is present, use an 18-2 cable to relay its 24VAC signal back to activate it: D1 - dry contacts, closed on call for aux. pool heat D2 - dry contacts, closed on call for aux. pool heat

## 208/230V POWER SUPPLY CONNECTIONS

Wire	Colour	Contactor (Label)
Line 2	Red	L2
Neutral*	-	no connection
Line 1	Black	L1

Connect "GND" to ground lug.

## OUTDOOR UNIT SIGNAL CONNECTIONS (24VAC)

Use an 18-3 outdoor rated cable to connect the accessory outdoor unit's signal connections (DET/DET/PWM+) to the matching connections in the pool conditioner's upper electrical box.

## OUTDOOR UNIT POWER CONNECTIONS (230VAC)

Use a 14-2 outdoor rated cable to connect the accessory outdoor unit's power supply terminals to the matching terminals in the pool conditioner's lower electrical box.

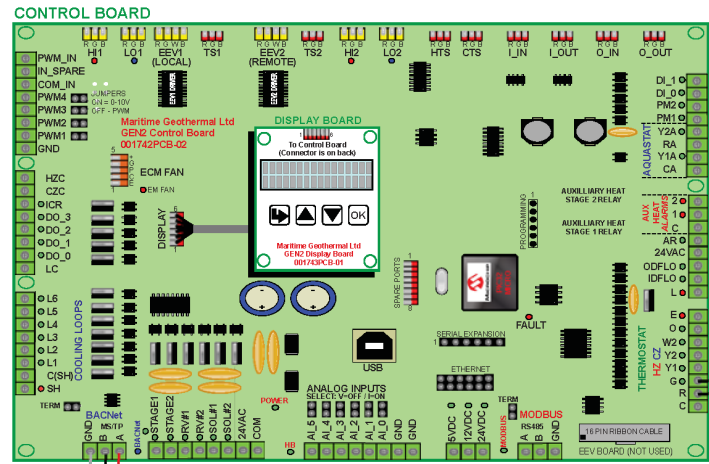

BACnet Connection

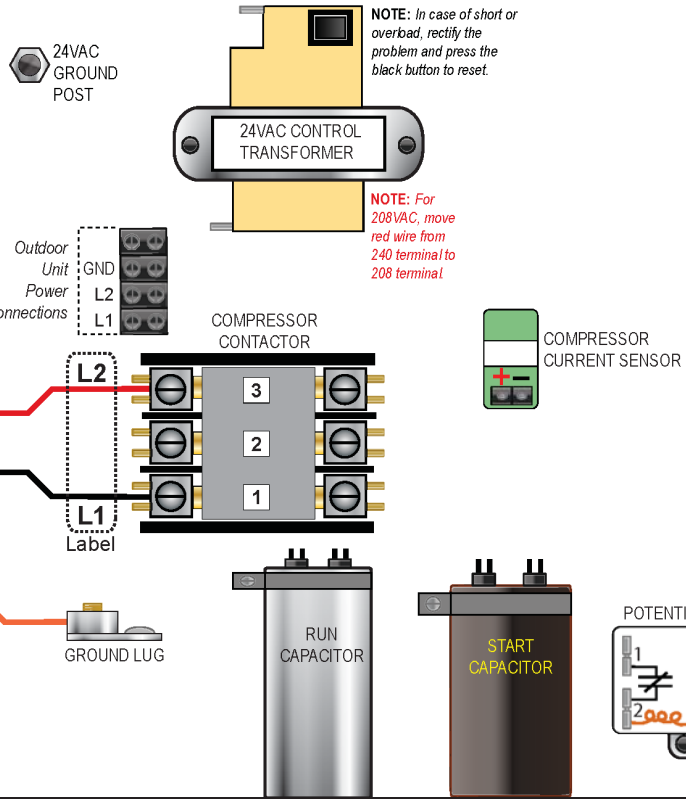
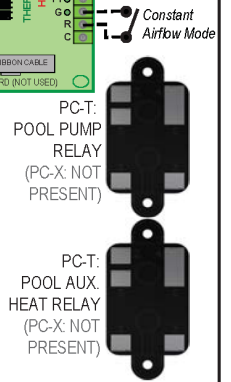
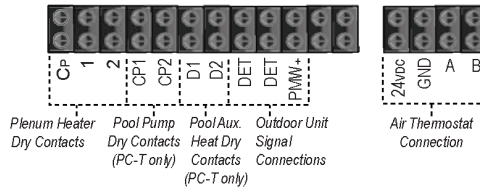

Drawn By D. RHEAULT	Date 2-Oct-2024
Checked By D. RHEAULT	Date 2-Oct-2024
Eng. Approved By	Date
Mfg. Approved By	Date
Approved By	Date

<b>MARITIME GEOTHERMAL LTD.</b> P.O. Box 2555 170 Plantation Rd. Pettitcodiac, NB CANADA E4Z 6H4	
Drawing Name PC-**-X-1S-T/X-KDER* Electrical Box Diagram	
Size LET	Drawing Number 002755ELB
Drawing Rev 01	Sheet 1 / 1

# PC-Series Schematic Diagram 208-3-60

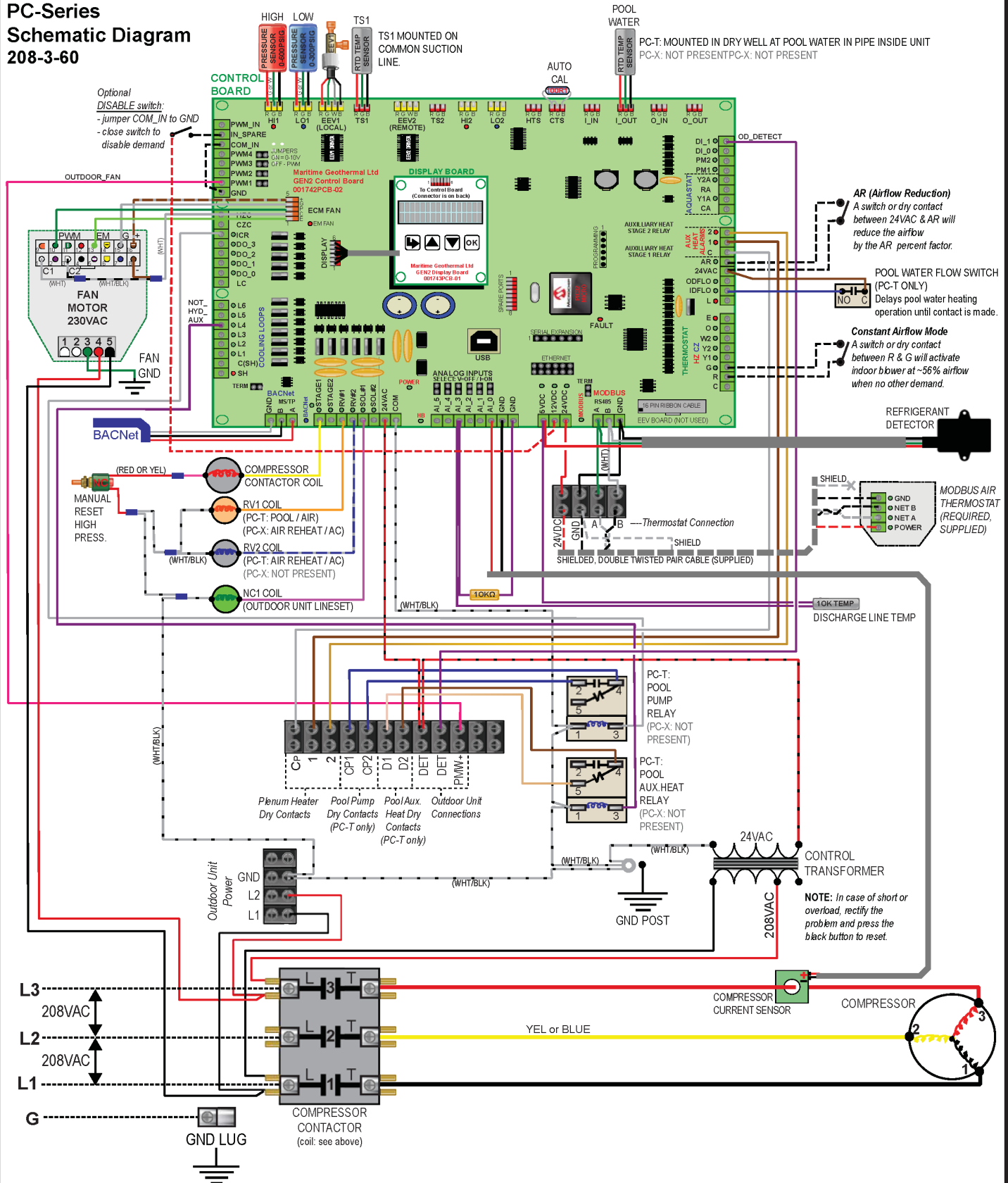

01	000326 (1R)	D. RHEAULT	D. RHEAULT	2-Oct-2024	Drawn By <b>D. RHEAULT</b> Date 2-Oct-2024 Checked By <b>D. RHEAULT</b> Date 2-Oct-2024 Eng. Approved By Date Mfg. Approved By Date Approved By Date	Date 2-Oct-2024 Date Date Date	<b>MARITIME GEOTHERMAL LTD.</b> P.O. Box 2555 170 Plantation Rd. Pettitcodiac, NB CANADA E4Z 6H4 Drawing Name <b>PC-** X-2S-T/X-KDER*</b> Schematic Diagram						
REV	ECO#	IMPL BY	APVD BY	DATE						Size	Drawing Number	Drawing Rev	Sheet
										LET	002756SCH	01	1 / 1

go to TABLE OF CONTENTS

**PC-Series  
Electrical Box Diagram  
208-3-60**

**AIR THERMOSTAT (REQUIRED)**

Connect the communicating thermostat to the terminal strip with supplied shielded, double twisted pair cable:

- A - communication: use **one twisted pair**
- B - power: use **other twisted pair**
- 24VDC - power: use **other twisted pair**
- GND - Ground

**CONSTANT AIRFLOW MODE**

A switch or dry contact between R & G will activate the indoor blower at ~56% airflow when no other demand.  
R - 24VAC  
G - blower activation

**BACnet CONNECTIONS (MS/TP RS-485)**

Use a shielded, twisted pair cable to connect the optional BACnet connections to the control board.

- A - communication: use **one twisted pair**
- B - Ground

BACnet Object	Activation
SYSTEM_G	Constant Airflow/Fan Recirculation Mode
SYSTEM_Y1	Air Reheat/Aux. Heat or Air Cool Demand
SYSTEM_O	Air Heating (OFF) / Air Cooling (ON)
SYSTEM_Y1A	Pool Water Heat Demand
SYSTEM_DH	Air Dehumidify Demand

**PLENUM HEATER DRY CONTACTS**

Use an 18-3 cable to connect the air plenum heater control board to the pool conditioner terminal strip:  
CP - 24VAC from plenum heater  
1 - dry contact, closed on call for electric heat stage 1  
2 - dry contact, closed on call for electric heat stage 2

**POOL PUMP DRY CONTACTS (PC-X: N/A)**

If pool pump control is required, use an 18-2 cable to relay a 24VAC signal to activate an external contactor:  
CP1 - dry contacts, closed on call for pool water flow  
CP2 - dry contacts, closed on call for pool water flow

**POOL AUXILIARY HEAT DRY CONTACTS (PC-X: N/A)**

If an auxiliary pool heating device is present, use an 18-2 cable to relay its 24VAC signal back to activate it:  
D1 - dry contacts, closed on call for aux. pool heat  
D2 - dry contacts, closed on call for aux. pool heat

**208V POWER SUPPLY CONNECTIONS**

Wire	Colour	Contactor (Label)
Line 3	Red	L3
Line 2	Blue	L2
Line 1	Black	L1

Connect "GND" to ground lug.

**OUTDOOR UNIT SIGNAL CONNECTIONS (24VAC)**

Use an 18-3 **outdoor rated** cable to connect the accessory outdoor unit's signal connections (DET/DET/PWM+) to the matching connections in the pool conditioner's upper electrical box.

**OUTDOOR UNIT POWER CONNECTIONS (230VAC)**

Use a 14-2 outdoor rated cable to connect the accessory outdoor unit's power supply terminals to the matching terminals in the pool conditioner's lower electrical box.

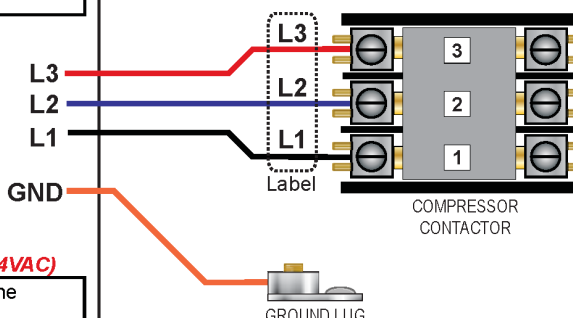
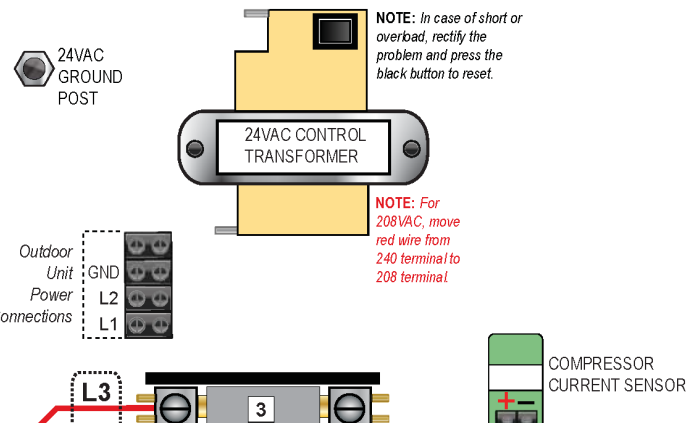
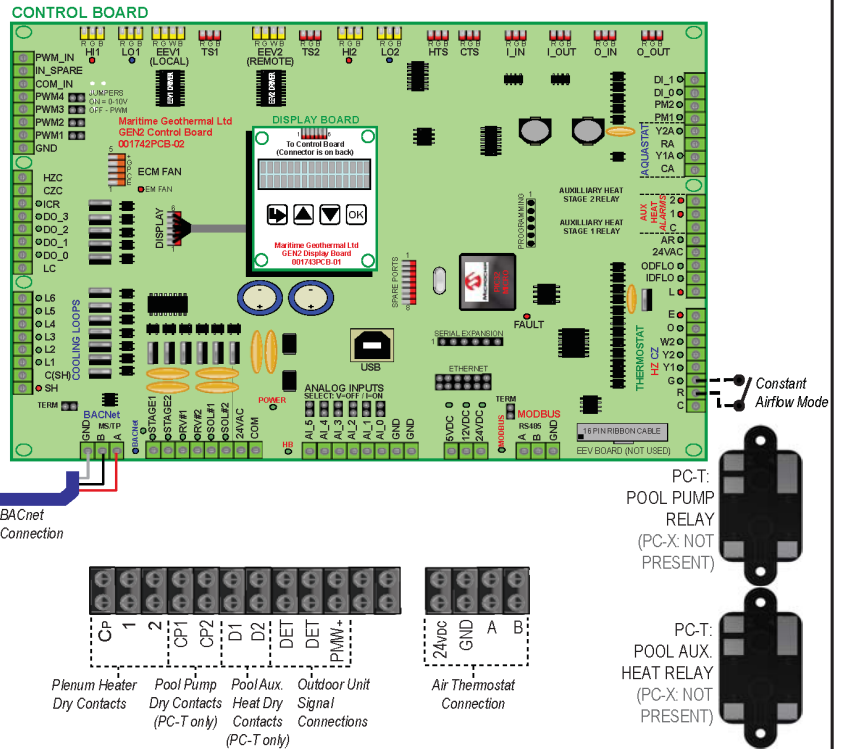

**IMPORTANT NOTE FOR 3 PHASE POWER**  
If on initial startup the compressor is noisy and not pumping, reverse L1 and L2 supply wires.

Drawn By D. RHEAULT	Date 2-Oct-2024	<b>MARITIME GEOTHERMAL LTD.</b> P.O. Box 2555 170 Plantation Rd. Pettitcodiac, NB CANADA E4Z 6H4
Checked By D. RHEAULT	Date 2-Oct-2024	
Eng. Approved By	Date	
Mfg. Approved By	Date	
Approved By	Date	
Drawing Name PC-**-X-2S-T/IX-KDER* Electrical Box Diagram		Size LET
Drawing Number 002757ELB		Drawing Rev 01
Sheet 1 / 1		



# PC-Series Schematic Diagram 460-3-60

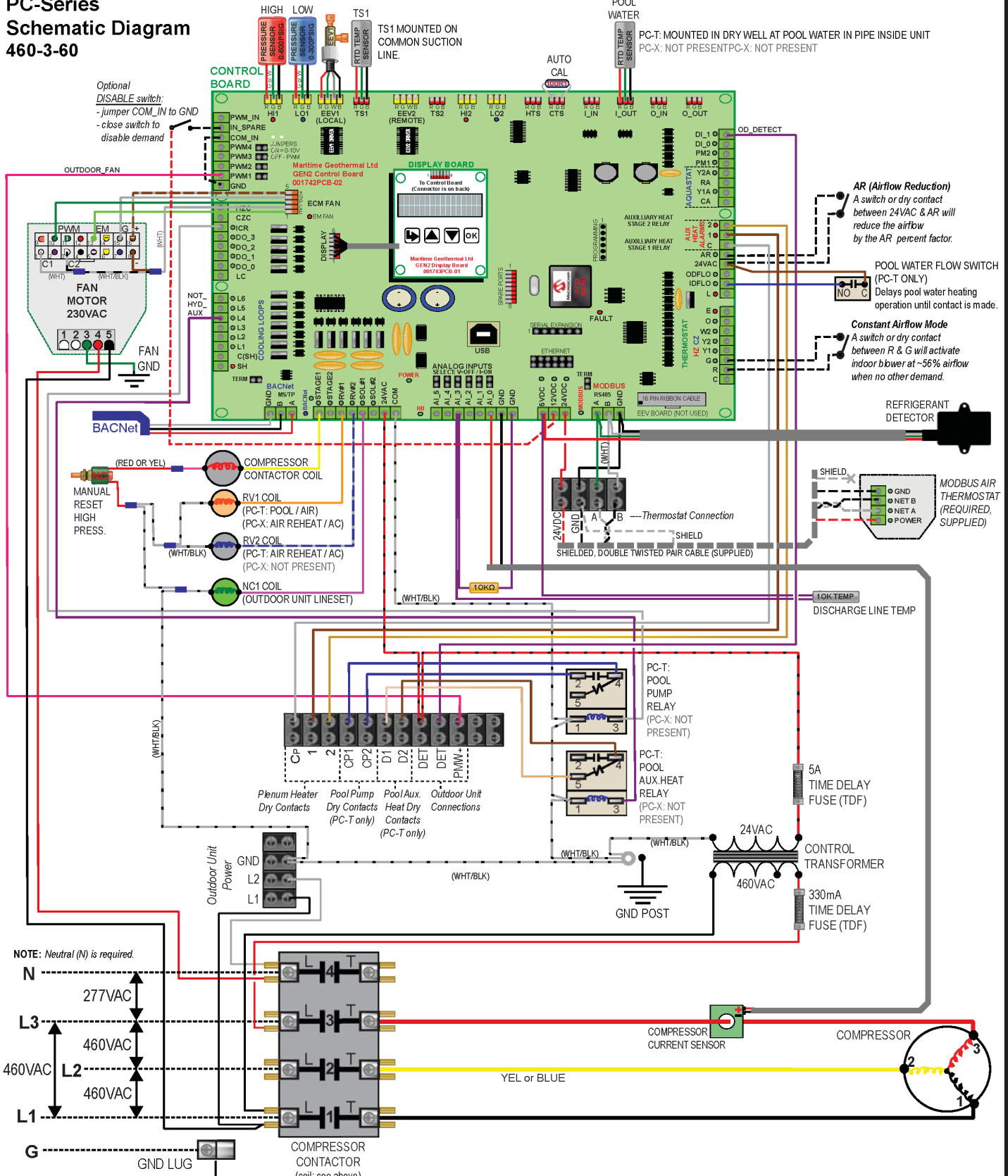

NOTE: Neutral (N) is required.

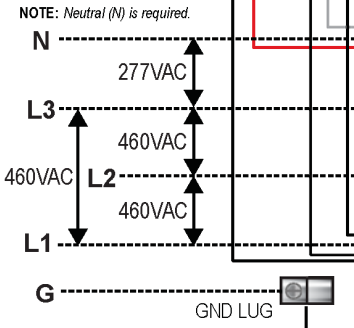

Drawn By D. RHEAULT	Date 2-Oct-2024		P.O. Box 2555 170 Plantation Rd. Petitcodiac, NB CANADA E4Z 6H4	
Checked By D. RHEAULT	Date 2-Oct-2024		Drawing Name PC-** X-4S-T/X-KDER* Schematic Diagram	
Eng. Approved By	Date		Size LET	Drawing Number 002758SCH
Mfg. Approved By	Date		Drawing Rev 01	Sheet 1 / 1
Approved By	Date			

# PC-Series Electrical Box Diagram 460-3-60

## AIR THERMOSTAT (REQUIRED)

Connect the communicating thermostat to the terminal strip with supplied shielded, double twisted pair cable:

- A - communication: use **one twisted pair**
- B - power: use **other twisted pair**

## CONSTANT AIRFLOW MODE

A switch or dry contact between R & G will activate the indoor blower at ~56% airflow when no other demand. R - 24VAC G - blower activation

## BACnet CONNECTIONS (MS/TP RS-485)

Use a shielded, twisted pair cable to connect the optional BACnet connections to the control board.

- A - communication: use **one twisted pair**
- B - Ground

BACnet Object	Activation
SYSTEM_G	Constant Airflow/Fan Recirculation Mode
SYSTEM_Y1	Air Reheat/Aux. Heat or Air Cool Demand
SYSTEM_O	Air Heating (OFF) / Air Cooling (ON)
SYSTEM_Y1A	Pool Water Heat Demand
SYSTEM_DH	Air Dehumidify Demand

## PLENUM HEATER DRY CONTACTS

Use an 18-3 cable to connect the air plenum heater control board to the pool conditioner terminal strip: CP - 24VAC from plenum heater  
1 - dry contact, closed on call for electric heat stage 1  
2 - dry contact, closed on call for electric heat stage 2

## POOL PUMP DRY CONTACTS (PC-X: N/A)

If pool pump control is required, use an 18-2 cable to relay a 24VAC signal to activate an external contactor: CP1 - dry contacts, closed on call for pool water flow CP2 - dry contacts, closed on call for pool water flow

## POOL AUXILIARY HEAT DRY CONTACTS (PC-X: N/A)

If an auxiliary pool heating device is present, use an 18-2 cable to relay its 24VAC signal back to activate it: D1 - dry contacts, closed on call for aux. pool heat D2 - dry contacts, closed on call for aux. pool heat

## 460/277V POWER SUPPLY CONNECTIONS

\*NOTE: Neutral (N) is required.

Wire	Colour	Contactors (Label)
Neutral*	White	N*
Line 3	Red	L3
Line 2	Blue	L2
Line 1	Black	L1

Connect "GND" to ground lug.

## OUTDOOR UNIT SIGNAL CONNECTIONS (24VAC)

Use an 18-3 **outdoor rated** cable to connect the accessory outdoor unit's signal connections (DET/DET/PWM+) to the matching connections in the pool conditioner's upper electrical box.

## OUTDOOR UNIT POWER CONNECTIONS (230VAC)

Use a 14-2 outdoor rated cable to connect the accessory outdoor unit's power supply terminals to the matching terminals in the pool conditioner's lower electrical box.

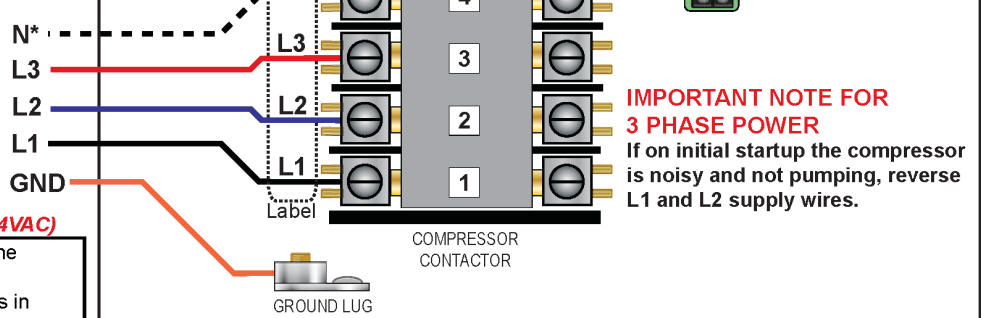
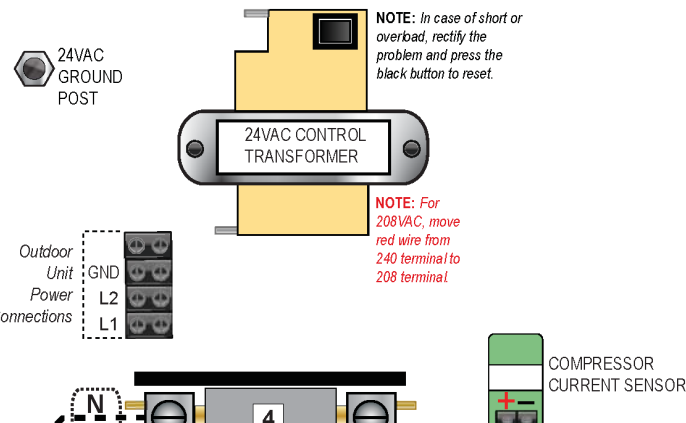
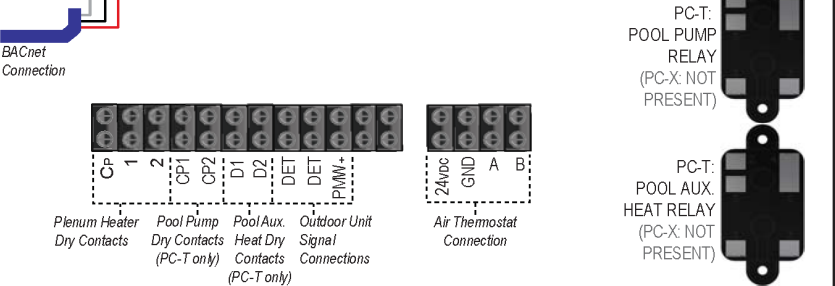
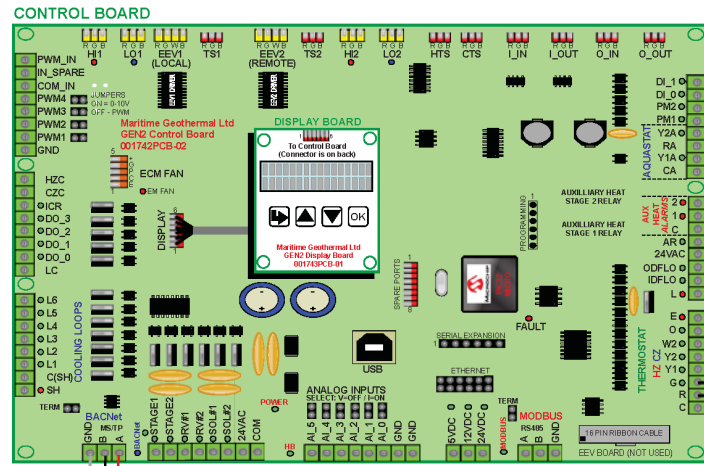

Drawn By D. RHEAULT	Date 2-Oct-2024		P.O. Box 2555 170 Plantation Rd. Petitcodiac, NB CANADA E4Z 6H4	
Checked By D. RHEAULT	Date 2-Oct-2024		Drawing Name PC-**-X-4S-T/X-KDER* Electrical Box Diagram	
Eng. Approved By	Date		Size LET	Drawing Number 002759ELB
Mfg. Approved By	Date		Drawing Rev 01	Sheet 1 / 1
Approved By	Date			

# AC2-45/55 Wiring Diagram

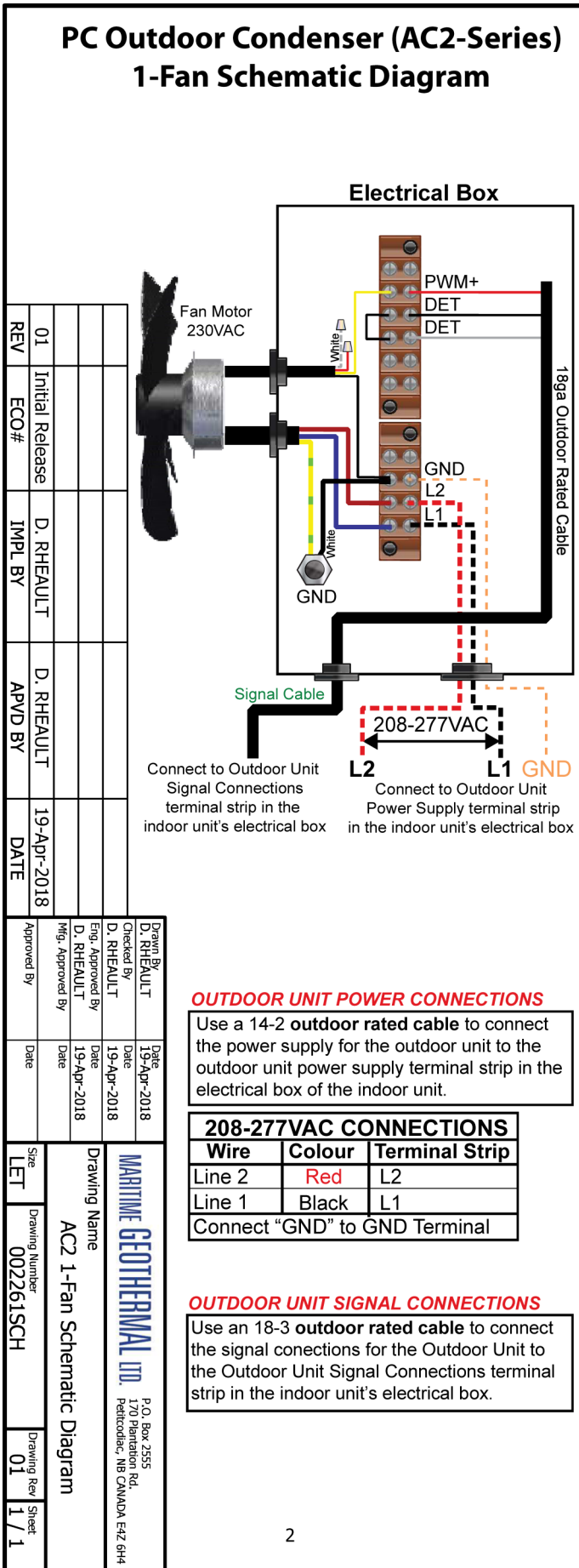

# AC2-65/75/80 Wiring Diagram

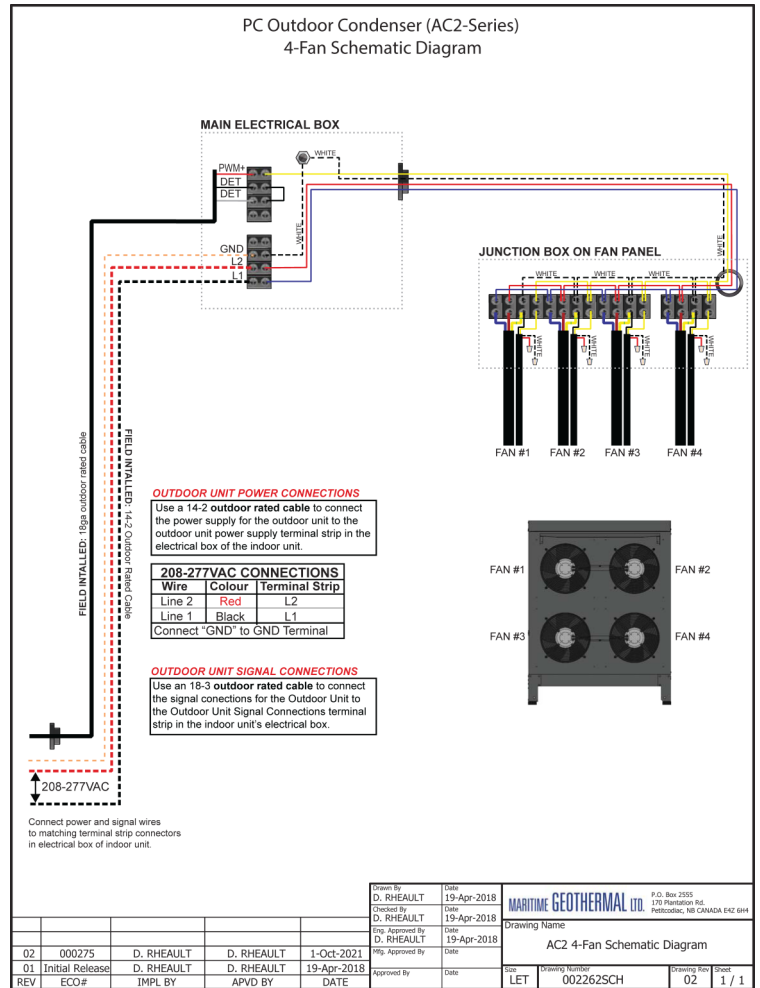

# PC-T Refrigeration Circuit - Pool Water Heat Mode

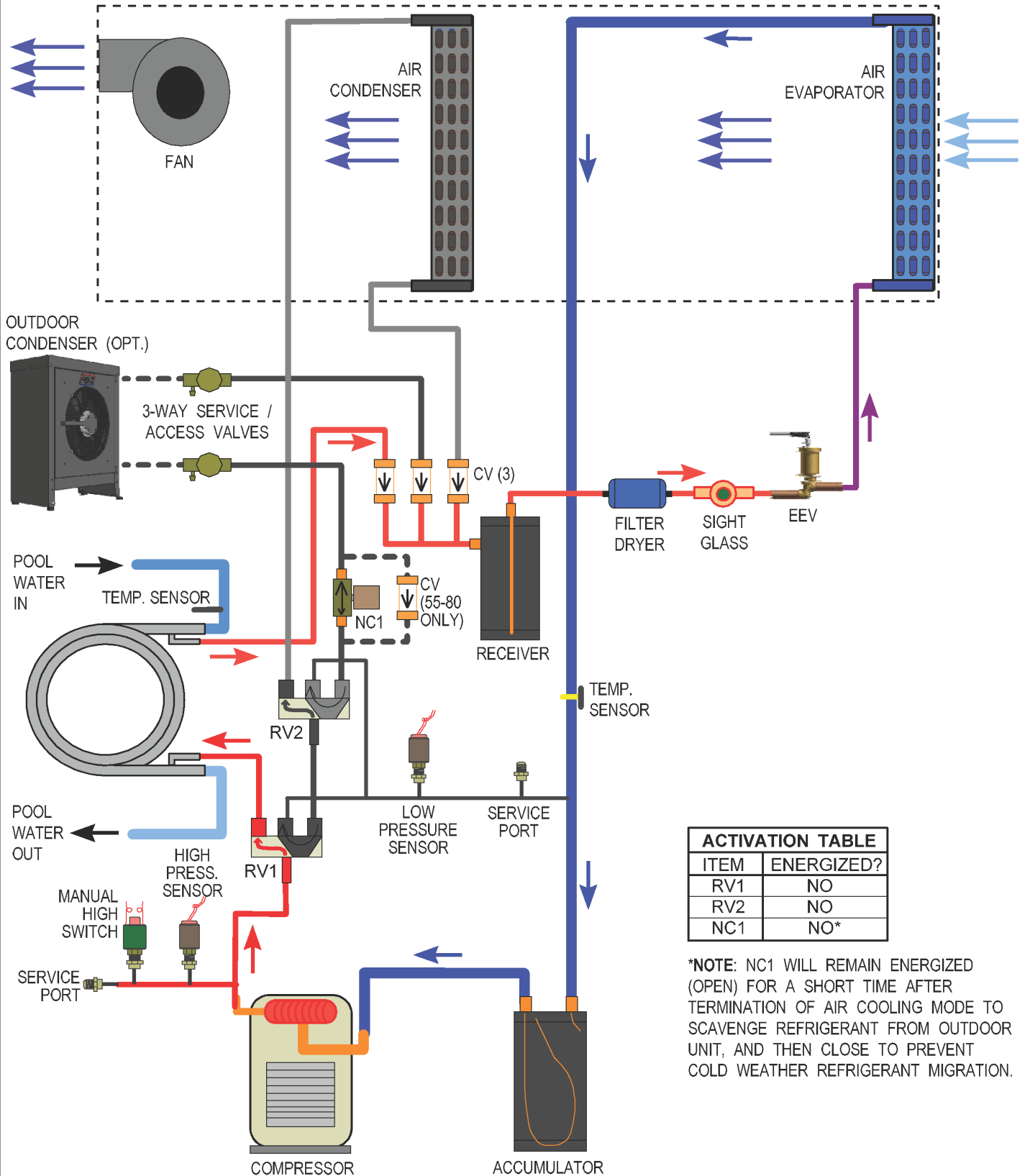

ACTIVATION TABLE	
ITEM	ENERGIZED?
RV1	NO
RV2	NO
NC1	NO*

\*NOTE: NC1 WILL REMAIN ENERGIZED (OPEN) FOR A SHORT TIME AFTER TERMINATION OF AIR COOLING MODE TO SCAVENGE REFRIGERANT FROM OUTDOOR UNIT, AND THEN CLOSE TO PREVENT COLD WEATHER REFRIGERANT MIGRATION.

05	000316	D. RHEAULT	D. RHEAULT	01 SEP 23	Drawn By Chris Geddes	Date 09 JAN 07	MARITIME GEOTHERMAL LTD. 170 Plantation Rd. Petitcodiac, NB E4Z 6H4	
04	000284	D. RHEAULT	D. RHEAULT	20 JAN 21	Checked By Chris Geddes	Date 09 JAN 07		
03	000271	D. RHEAULT	D. RHEAULT	06 MAR 19	Approved By Chris Geddes (ENG)	Date 09 JAN 07	Drawing Name PC-***-T Refrigeration Circuit Diagram - Pool Water Heat Mode	
02	000236	D. RHEAULT	D. RHEAULT	01 MAY 15	Approved By (MFG)	Date		
01	Initial Release	C. GEDDES	C. GEDDES	09 JAN 07	Approved By	Date	Size A	
REV	ECO #	IMPL BY	APVD BY	DATE			Drawing Number <b>000352RCD</b>	
							REV <b>05</b>	SHEET <b>1 of 1</b>

go to TABLE OF CONTENTS

## PC-T Refrigeration Circuit - Air Reheat Mode

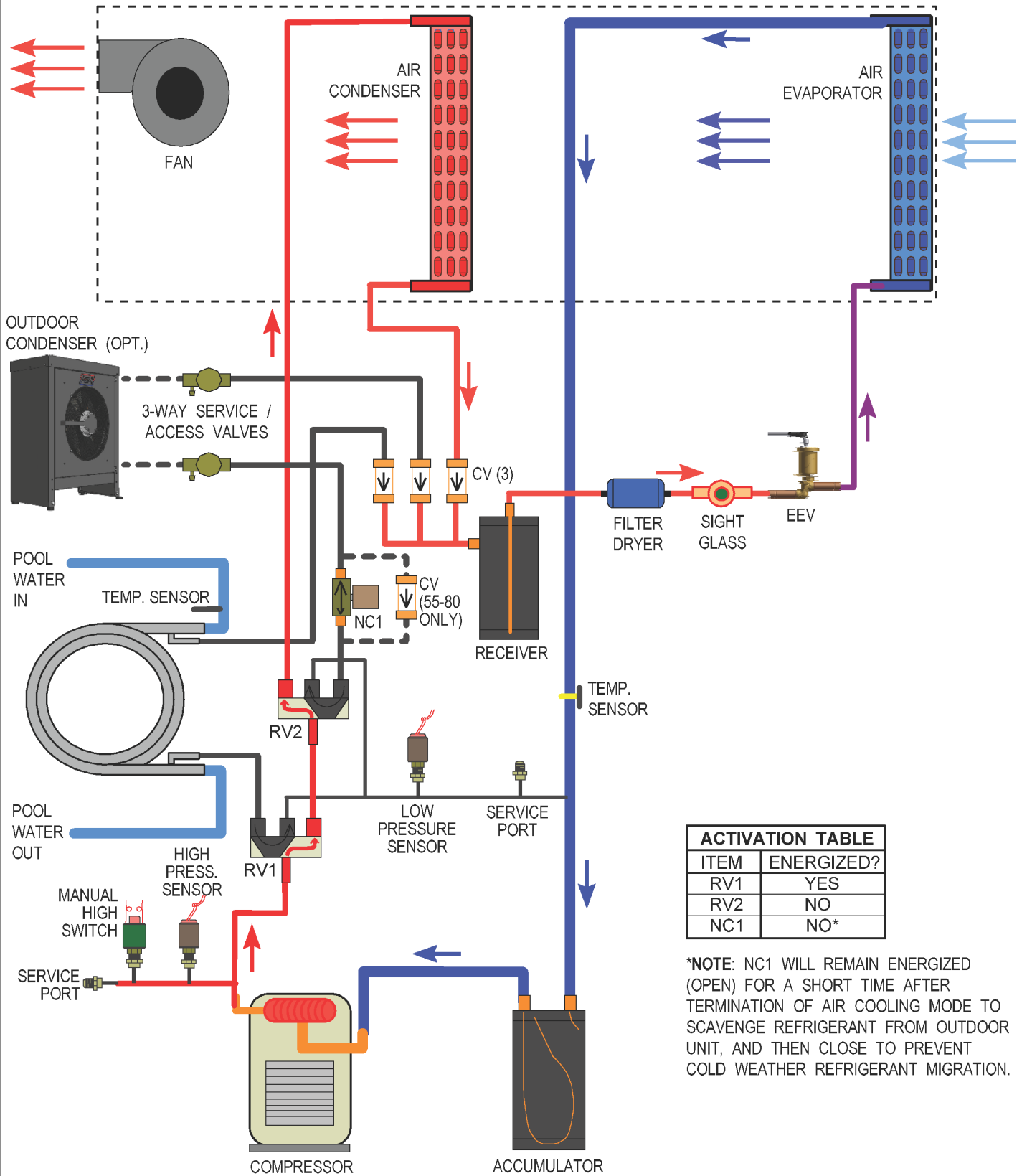

ACTIVATION TABLE	
ITEM	ENERGIZED?
RV1	YES
RV2	NO
NC1	NO*

\*NOTE: NC1 WILL REMAIN ENERGIZED (OPEN) FOR A SHORT TIME AFTER TERMINATION OF AIR COOLING MODE TO SCAVENGE REFRIGERANT FROM OUTDOOR UNIT, AND THEN CLOSE TO PREVENT COLD WEATHER REFRIGERANT MIGRATION.

05	000316	D. RHEAULT	D. RHEAULT	01 SEP 23	Drawn By Chris Geddes	Date 09 JAN 07	<b>MARITIME GEOTHERMAL LTD.</b>	170 Plantation Rd. Petitcodiac, NB E4Z 6H4
04	000284	D. RHEAULT	D. RHEAULT	20 JAN 21	Checked By Chris Geddes	Date 09 JAN 07		
03	000271	D. RHEAULT	D. RHEAULT	06 MAR 19	Approved By Chris Geddes (ENG)	Date 09 JAN 07	Drawing Name PC-***T Refrigeration Circuit Diagram - Air Reheat Mode	
02	000236	D. RHEAULT	D. RHEAULT	01 MAY 15	Approved By (MFG)	Date	Size A	Drawing Number 000353RCD
01	Initial Release	C. GEDDES	C. GEDDES	09 JAN 07	Approved By	Date	REV 05	SHEET 1 of 1
REV	ECO #	IMPL BY	APVD BY	DATE				

go to TABLE OF CONTENTS

# PC-T Refrigeration Circuit - Heat Rejection Mode

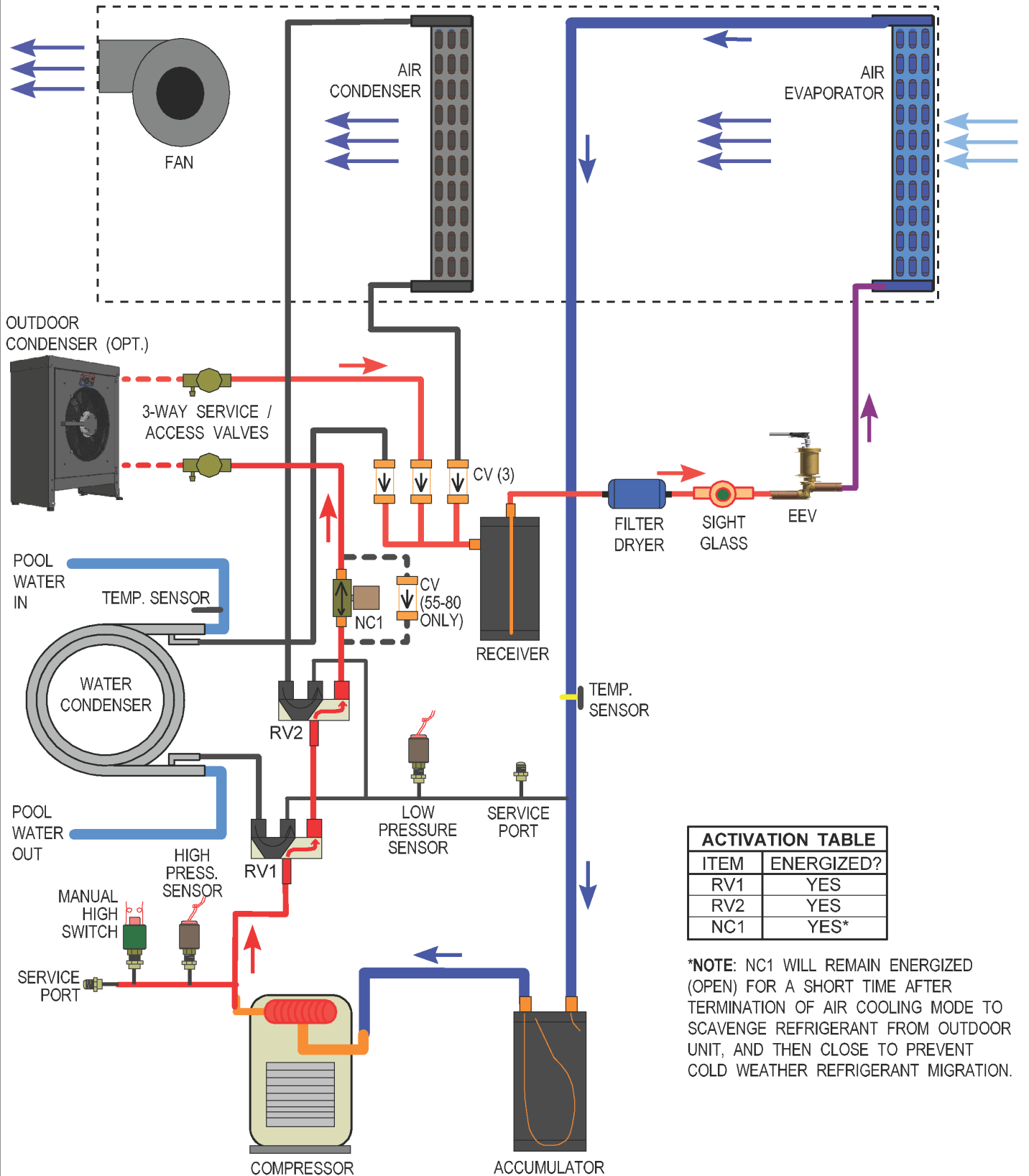

ACTIVATION TABLE	
ITEM	ENERGIZED?
RV1	YES
RV2	YES
NC1	YES*

\*NOTE: NC1 WILL REMAIN ENERGIZED (OPEN) FOR A SHORT TIME AFTER TERMINATION OF AIR COOLING MODE TO SCAVENGE REFRIGERANT FROM OUTDOOR UNIT, AND THEN CLOSE TO PREVENT COLD WEATHER REFRIGERANT MIGRATION.

05	000316	D. RHEAULT	D. RHEAULT	01 SEP 23	Drawn By Chris Geddes	Date 09 JAN 07	MARITIME GEOTHERMAL LTD. 170 Plantation Rd. Petitcodiac, NB E4Z 6H4	
04	000284	D. RHEAULT	D. RHEAULT	20 JAN 21	Checked By Chris Geddes	Date 09 JAN 07		
03	000271	D. RHEAULT	D. RHEAULT	06 MAR 19	Approved By Chris Geddes (ENG)	Date 09 JAN 07	Drawing Name PC-***T Refrigeration Circuit Diagram - Heat Rejection Mode	
02	000236	D. RHEAULT	D. RHEAULT	01 MAY 15	Approved By (MFG)	Date		
01	Initial Release	C. GEDDES	C. GEDDES	09 JAN 07	Approved By	Date	Size A	
REV	ECO #	IMPL BY	APVD BY	DATE			Drawing Number <b>000354RCD</b>	
							REV <b>05</b>	SHEET <b>1 of 1</b>

go to TABLE OF CONTENTS

## PC-X Refrigeration Circuit - Air Reheat Mode

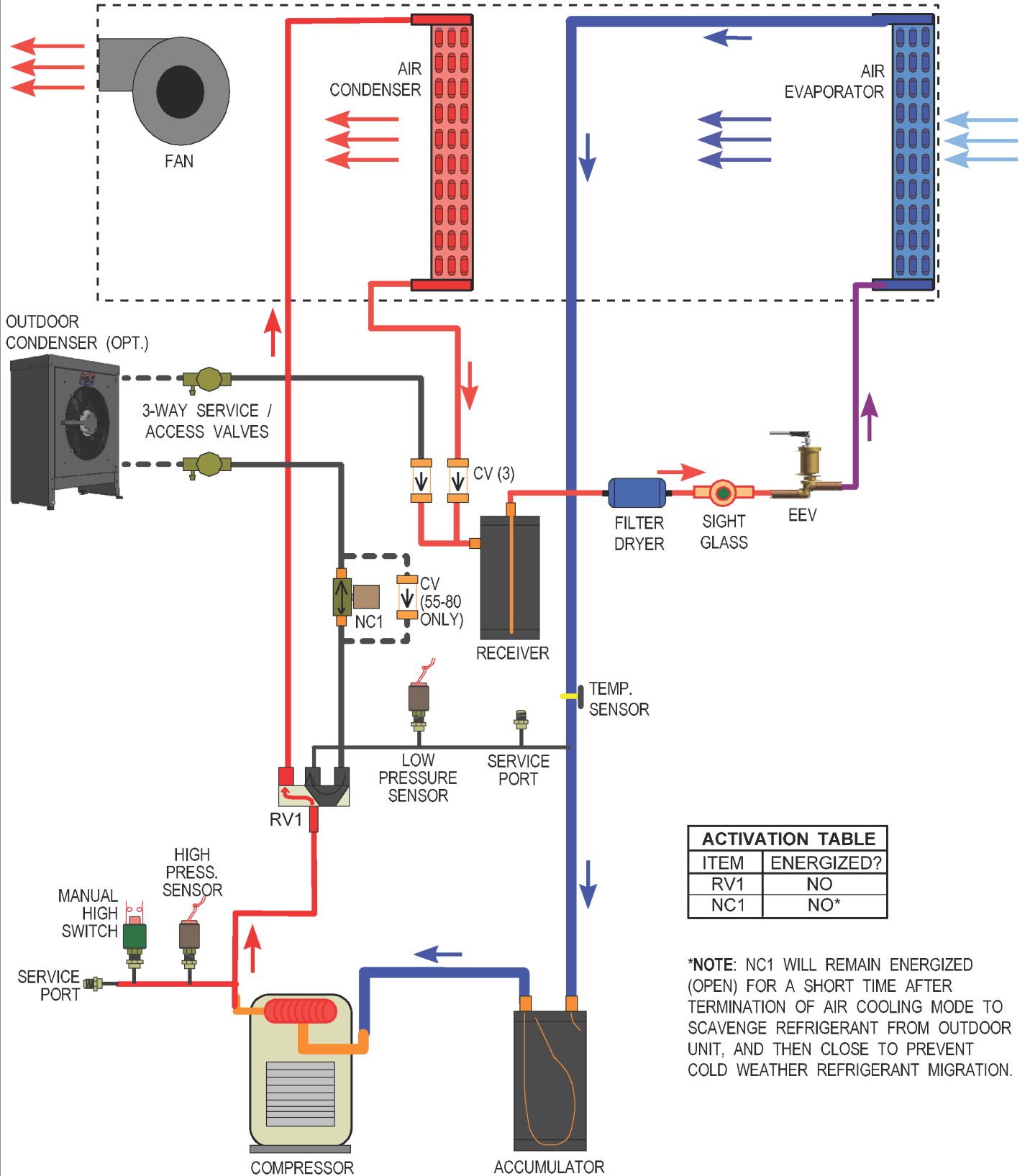

ACTIVATION TABLE	
ITEM	ENERGIZED?
RV1	NO
NC1	NO*

\*NOTE: NC1 WILL REMAIN ENERGIZED (OPEN) FOR A SHORT TIME AFTER TERMINATION OF AIR COOLING MODE TO SCAVENGE REFRIGERANT FROM OUTDOOR UNIT, AND THEN CLOSE TO PREVENT COLD WEATHER REFRIGERANT MIGRATION.

01	Initial Release	D. RHEAULT	D. RHEAULT	1-May-2024	Drawn By Dan Rheault	Date 1-May-2024	<b>MARITIME GEOTHERMAL LTD.</b> 170 Plantation Rd. Petitcodiac, NB E4Z 6H4
REV	ECO #	IMPL BY	APVD BY	DATE	Checked By Dan Rheault	Date 1-May-2024	
					Approved By (ENG) Dan Rheault	Date 1-May-2024	Drawing Name PC-***-X Refrigeration Circuit Diagram - Air Reheat Mode
					Approved By (MFG)	Date	Size A
					Approved By	Date	Drawing Number <b>002698RCD</b>
							REV <b>01</b>
							SHEET 1 of 1

# PC-X Refrigeration Circuit - Heat Rejection Mode

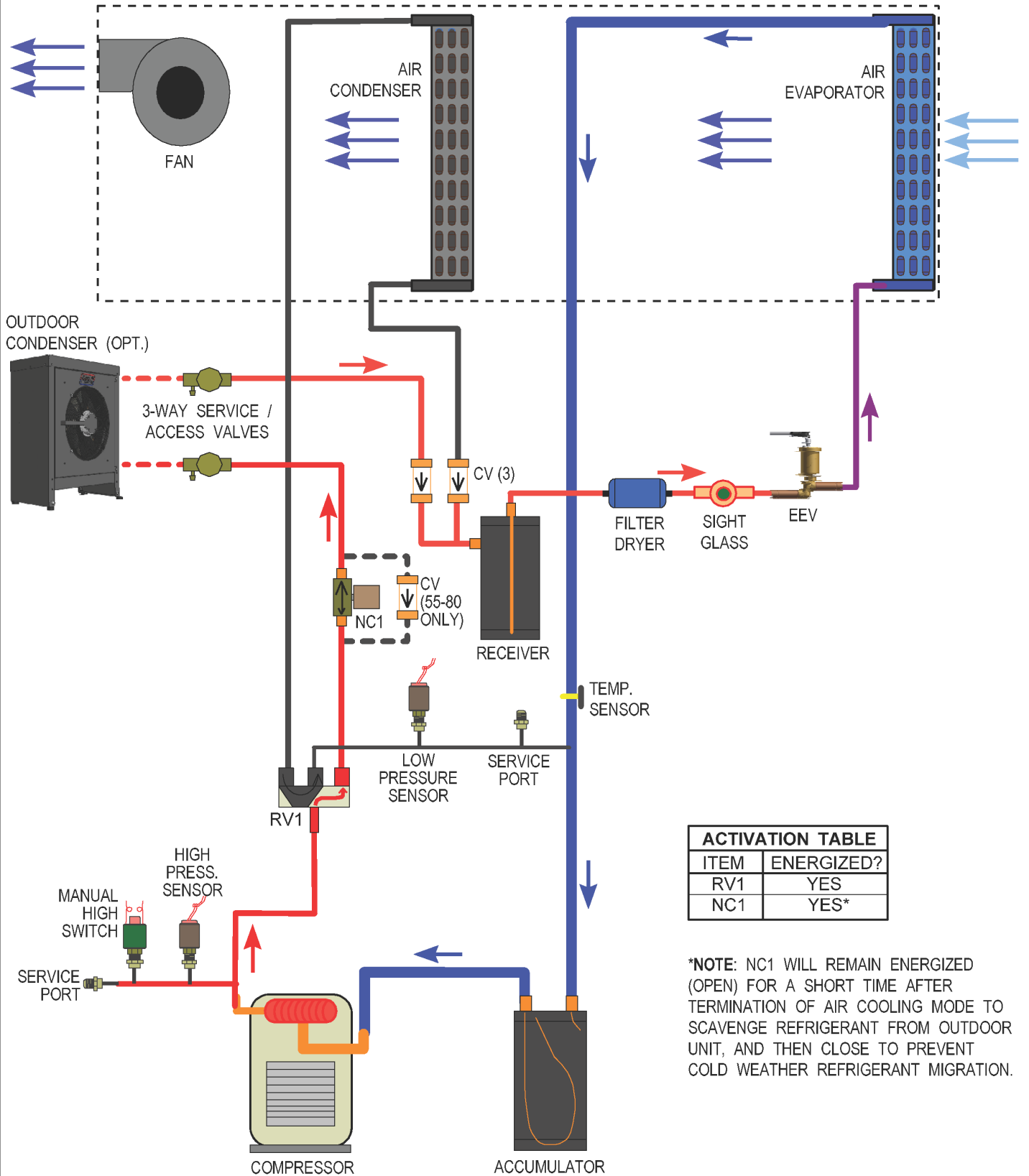

ACTIVATION TABLE	
ITEM	ENERGIZED?
RV1	YES
NC1	YES*

\*NOTE: NC1 WILL REMAIN ENERGIZED (OPEN) FOR A SHORT TIME AFTER TERMINATION OF AIR COOLING MODE TO SCAVENGE REFRIGERANT FROM OUTDOOR UNIT, AND THEN CLOSE TO PREVENT COLD WEATHER REFRIGERANT MIGRATION.

01	Initial Release	D. RHEAULT	D. RHEAULT	1-May-2024	Drawn By Dan Rheault	Date 1-May-2024	<b>MARITIME GEOTHERMAL LTD.</b> 170 Plantation Rd. Petitcodiac, NB E4Z 6H4
REV	ECO #	IMPL BY	APVD BY	DATE	Checked By Dan Rheault	Date 1-May-2024	
					Approved By Dan Rheault (ENG)	Date 1-May-2024	
					Approved By (MFG)	Date	Drawing Name PC-***X Refrigeration Circuit Diagram - Heat Rejection Mode
					Approved By	Date	Size A
							Drawing Number 002699RCD
							REV 01
							SHEET 1 of 1

go to TABLE OF CONTENTS



# Dimensions: PC (All Model Sizes)

All dimensions in inches

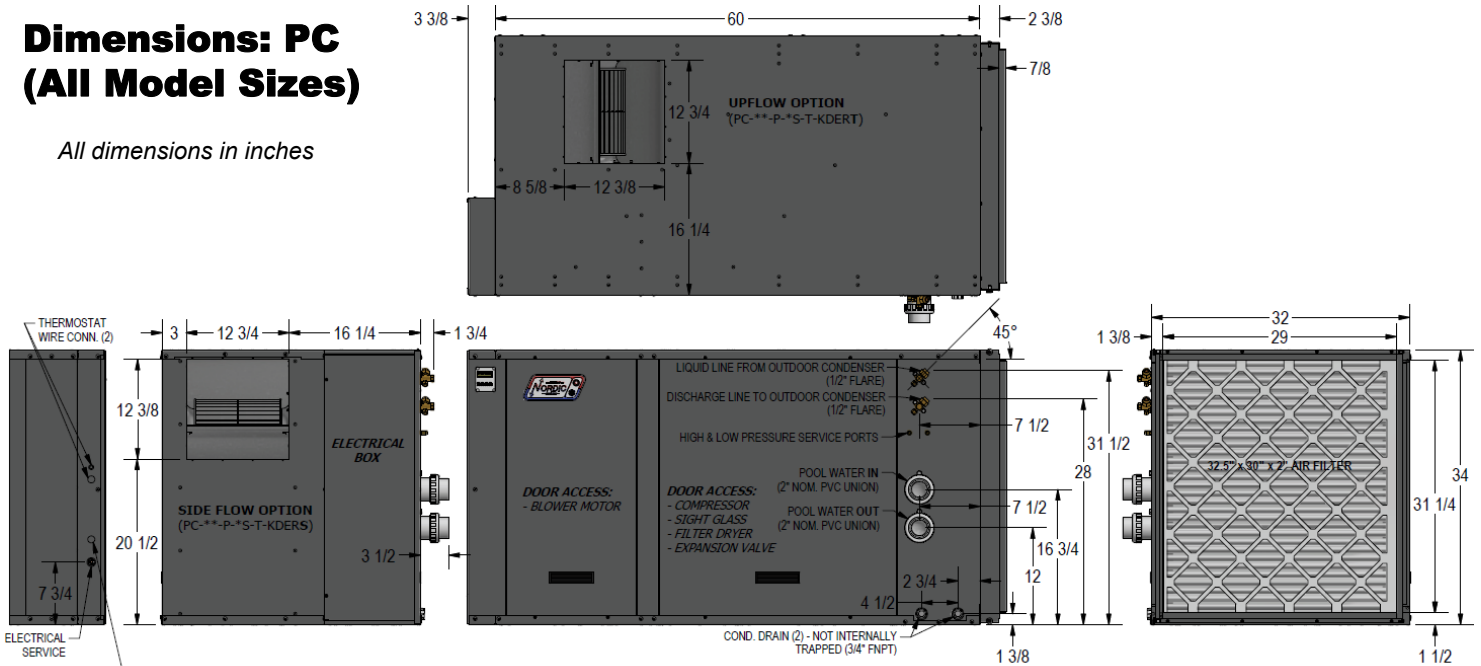

## RECOMMENDED CLEARANCES

FRONT **2 FT**

LEFT SIDE **2 FT**

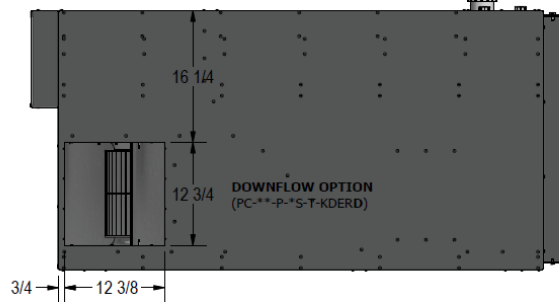

# Dimensions: AC2-45/55

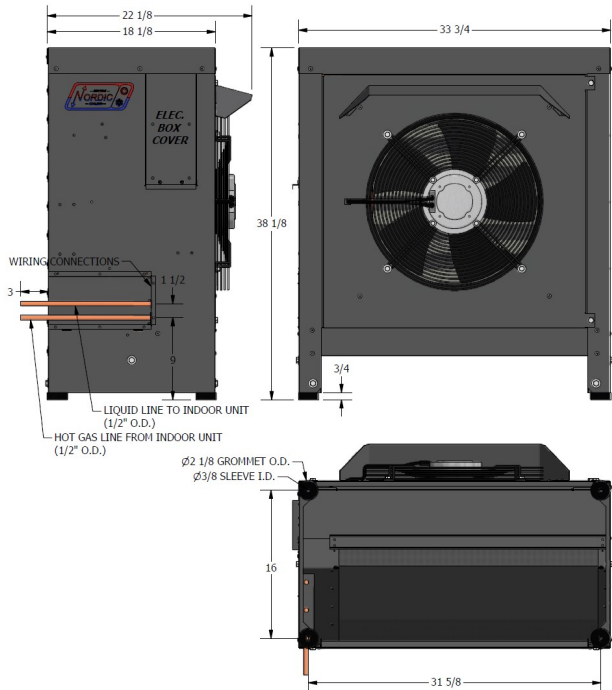

# Dimensions: AC2-65/75/80

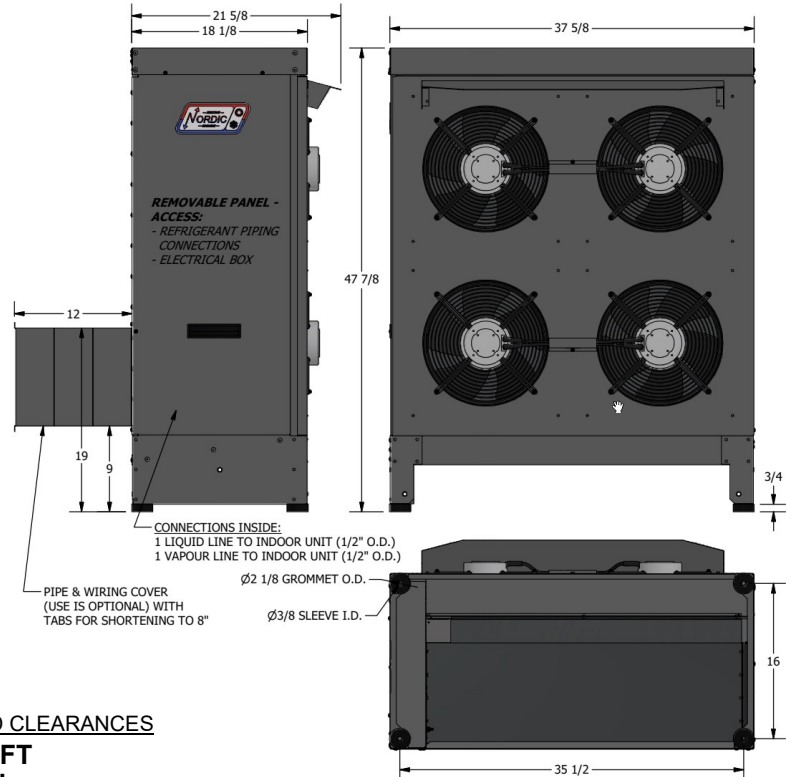

## RECOMMENDED CLEARANCES

FRONT **10-16 FT**

BACK SIDE **12"**

LEFT SIDE **2 FT**

# Appendix A - GEN2 Control Board Description

The picture below shows the locations of the connectors and LED indicators of the control board. The control board offers many features such as short circuit protection on all digital outputs, Real Time Clock with super capacitor for backup power, WiFi capability, relay outputs for plenum heater control (if equipped), USB port, PIC32 microcontroller, etc.

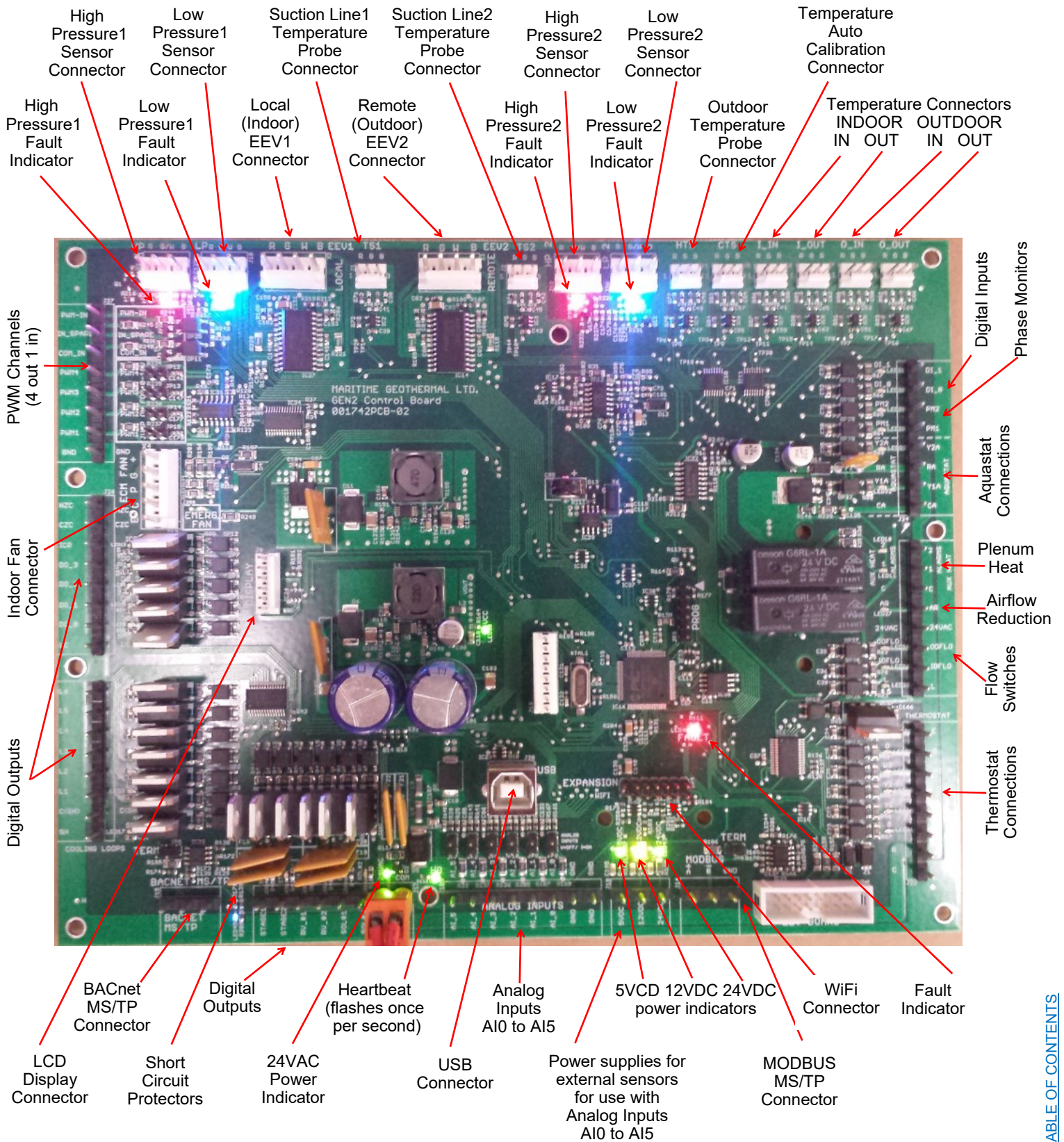

The tables describe the connections starting with the top of the board and working around the board counter clock-wise.

<b>TABLE A1 - Control Board Connector Descriptions (Top)</b>		
<b>Signal</b>	<b>Description</b>	
HP1/HI1	High Pressure Sensor 1	Measures compressor discharge pressure.
LP1/LO1	Low Pressure Sensor 1	Measures compressor suction pressure.
EEV1	Local EEV	EEV
TS1	Suction Line Temperature 1	Mounted to suction line.
EEV2	Remote EEV	Not used.
TS2	Suction Line Temperature 2	Not used.
HP2/HI2	High Pressure Sensor 2	Not used.
LP2/LO2	Low Pressure Sensor 2	Not used.
HTS	Outdoor Temperature	Not used.
CTS	Auto Calibration	Resistor in connector for auto-calibration reference (32°F—0°C).
I_IN	Indoor Loop IN	Not used.
I_OUT	Indoor Loop OUT	Mounted in dry well on pool water IN pipe inside unit ( <i>PC-T only</i> )
O_IN	Outdoor Loop IN	Not used.
O_OUT	Outdoor Loop OUT	Not used.

<b>TABLE A2 - Control Board Connector Descriptions (Left Side)</b>		
<b>Name</b>	<b>Description</b>	
PWM_IN	Signal for PWM IN	Not used.
IN_SPARE	Spare digital input	Switch or dry contact from 12VDC to disable unit (also COM_IN to GND).
COM_IN	Common for PWM IN	Jumper to GND for disable functionality.
PWM4	PWM / 0-10VDC output	Not used.
PWM3	PWM / 0-10VDC output	Not used.
PWM2	PWM / 0-10VDC output	Not used.
PWM1	PWM / 0-10VDC output	Control signal for fan in optional outdoor unit.
GND	Ground	Jumper to COM_IN for disable functionality.
HZC	Hot Zone Circulator	Not used.
CZC	Cold Zone Circulator	Not used.
ICR	Internal Circulator Relay	Signal for dry contact pool pump control - CP1 and CP2 ( <i>PC-T only</i> )
DO_3	Digital output	Not used.
DO_2	Digital output	Not used.
DO_1	Digital output	Not used.
DO_0	Digital output	Not used.
LC	Loop common (ground)	Not used.
L6	Loop6	Not used.
L5	Loop5	Not used.
L4	NOT_HYD_AUX	Output OFF when auxiliary pool heat required; operates D1-D2 dry contacts.
L3	Loop3	Not used.
L2	Loop2	Not used.
L1	Loop1	24VAC output to operate 3-way valve or ground loop circulator for heat rejection.
C(SH)	Soaker Hose common	Used with L1.
SH	Soaker Hose	Not used.

<b>TABLE A3 - Control Board Connector Descriptions (Bottom)</b>		
<b>Name</b>	<b>Description</b>	
GND	BACnet MS/TP	Ground for shield if required.
B	BACnet MS/TP	RS-485 for BACnet communication.
A	BACnet MS/TP	RS-485 for BACnet communication.
STAGE1	Compressor Stage 1	Starts / stops the compressor.
STAGE2	Compressor Stage 2	Not used.
RV_#1	Reversing Valve #1	Off in pool heat mode, energized in air reheat or heat rejection modes.
RV_#2	Reversing Valve #2	Off in pool heat mode or air reheat modes, energized in heat rejection mode.
SOL#1	Solenoid#1 (NC#1)	Off in pool heat mode or air reheat modes, energized in heat rejection mode.
SOL#2	Solenoid#2	Optional refrigerant vent fan relay/contactactor.
24VAC	Power supply for board	24VAC power for control board.
COM	Power supply for board	GND for control board.
AI_5	Analog In Channel 5	Not used.
AI_4	Analog In Channel 4	Not used.
AI_3	Analog In Channel 3	Compressor discharge line temperature sensor.
AI_2	Analog In Channel 2	Not used.
AI_1	Analog In Channel 1	Not used.
AI_0	Analog In Channel 0	Compressor current sensor.
GND	Ground pin	Ground for analog sensors.
GND	Ground pin	Ground for analog sensors.
5VDC	Power for analog sensors	5VDC regulated power supply for sensors.
12VDC	Power for analog sensors	12VDC regulated power supply for sensors.
24VDC	Power for analog sensors	24VDC unregulated power supply for room sensor/user interface (air thermostat).
A	MODBUS	RS485 communication for refrigerant leak detector and air thermostat.
B	MODBUS	RS485 communication for refrigerant leak detector and air thermostat.
GND	MODBUS	Ground.

**TABLE A4 - Control Board Connector Descriptions (Right Side)**

Signal	Description	
DI_1	OD_DETECT	24vac input for detection of optional outdoor unit.
DI_0	Digital Input0	Not used.
PM2	Phase Monitor2	Not used.
PM1	Phase Monitor1	Not used.
Y2A	Aquastat Stage2	Not used.
RA	Aquastat Power (24VAC)	Not used.
Y1A	Aquastat Stage1	Not used.
CA	Aquastat Power (Ground)	Not used.
2	Plenum Heat Stage2	Electric auxiliary heat stage 1 (turns on or off).
1	Plenum Heat Stage1	Electric auxiliary heat stage 2 (turns on or off).
C	Plenum Heat Common	Ground for electric auxiliary heat control.
AR	Airflow Reductions	24vac input for reduction of airflow by the AR percent factor.
24VAC	Power	24vac output for AR above and IDFLO below.
ODFLO	Outdoor Flow Switch	Not used.
IDFLO	Indoor Flow Switch	Pool water flow switch.
L	Thermostat Lockout Indicator	Not used.
E	Thermostat Emergency Heat	Not used.
O	Thermostat Heat/Cool	Not used.
W2	Thermostat Auxiliary Heat	Not used.
Y2	Thermostat Stage2	Not used.
Y1	Thermostat Stage1	Not used.
G	Thermostat Fan	Connect to R through dry contact to enable fan recirculation mode.
R	Thermostat Power (24VAC)	Used with G above.
C	Thermostat Power (Ground)	Not used.

# Appendix B - USB Driver Installation (Windows 10 & earlier)

**NOTE:** This step is *not necessary* for Windows 11.

The first step in connecting a **Windows 10 or earlier** laptop computer to the control board is to install the USB driver.

The easiest way to install the USB driver is from the **USB drive included with the unit**. Insert the USB stick into a Windows computer, and open a File Explorer window to view its contents:

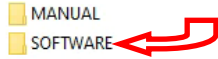

Double click on the SOFTWARE folder to show its contents:



To install the USB driver, double click on **Step 1** and follow the prompts, clicking “allow” or “yes” as required.

If the USB drive is not available, the same files can be **downloaded from the web page**.

1. Go to [www.nordicghp.com](http://www.nordicghp.com), Download Software page:

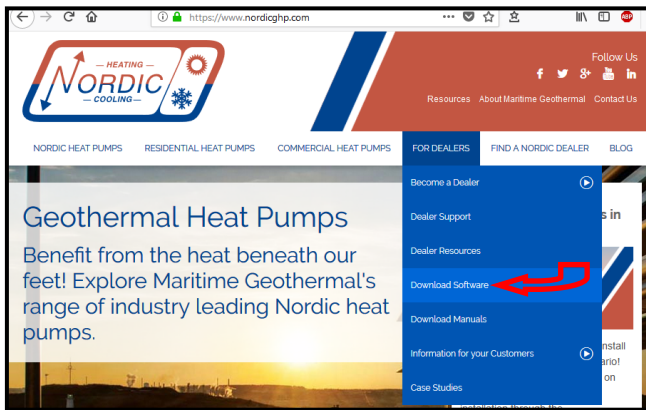

2. Click on **MGL GEN2 USB Driver Installer** to download it:

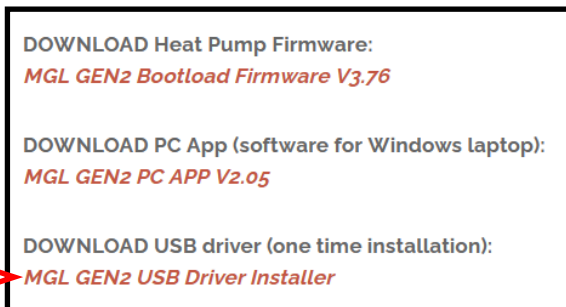

3. Choose “Open with Windows Explorer”, and hit “OK”.  
(If the choice window doesn't pop up, find the downloaded file in your browser downloads and double click on it.)

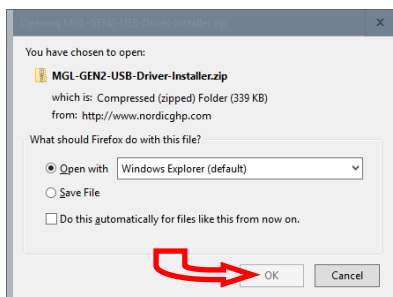

4. In the window that is displayed, click and hold down the mouse button on the folder name, and drag to your desktop:

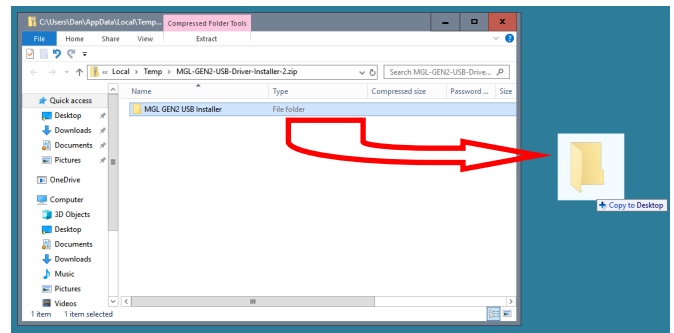

5. Double click on the folder you just dragged onto the desktop, then double click on the “USBDriverInstaller” file:

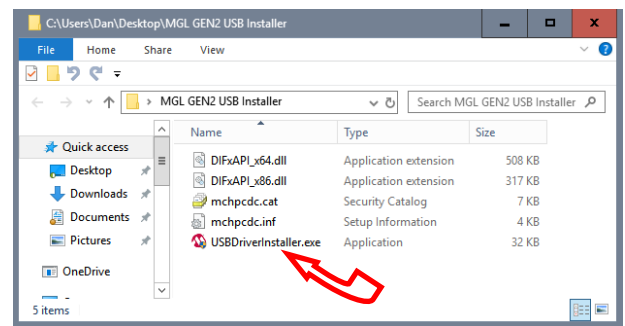

6. In the next window, click on “Install Drivers”:

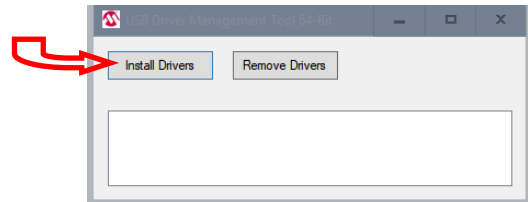

7. You will see a message indicating the driver was installed successfully. You are now ready to install the PC App.

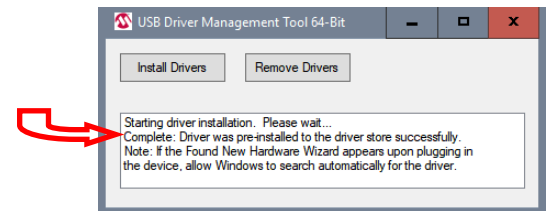

# Appendix C - PC App Installation (Windows 11)

The PC App allows detailed interfacing with the control board using a Windows laptop computer. These instructions are for **Windows 11**.

The easiest way to install the PC App is from the **USB drive included with the unit**. Insert the USB stick into a Windows computer, and open a File Explorer window to view its contents:

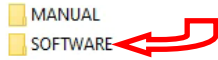

Double click on the **SOFTWARE** folder to show its contents:

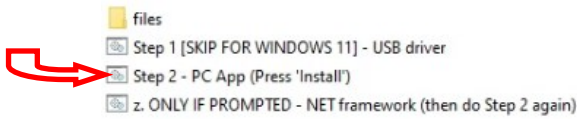

Double click on **Step 2** and follow the prompts, clicking “More info”, “Run anyway”, “Install”, or similar on any warning windows which pop up, perhaps more than once. Pictures of warning windows you might encounter are shown below in step 8.

If the USB stick drive is not available, the same file can be **downloaded from the web page**.

1. Go to [www.nordicghp.com](http://www.nordicghp.com), Download Software page:

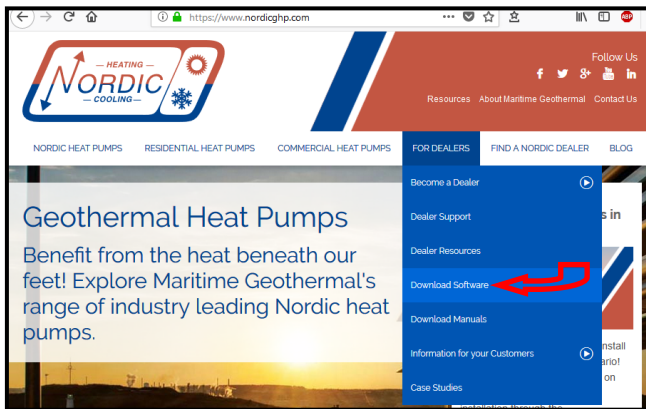

2. Click on **MGL GEN2 PC APP V2\_\_** to download it:

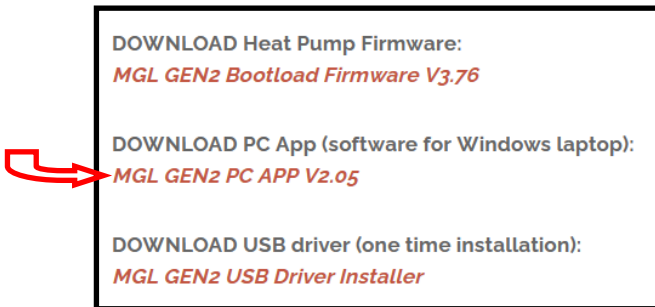

3. You may see a warning like this one. Click as shown:

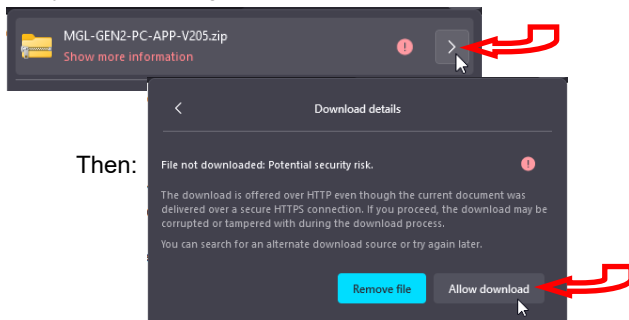

4. Click on the downloads icon on your browser, or otherwise view a list of your downloaded files:

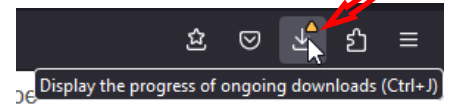

5. Then click on the .zip file to open it in a File Explorer window:

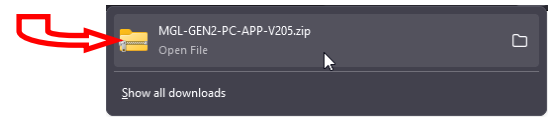

6. In the window that is displayed, click and hold down the mouse button on the folder name, and drag to your desktop:

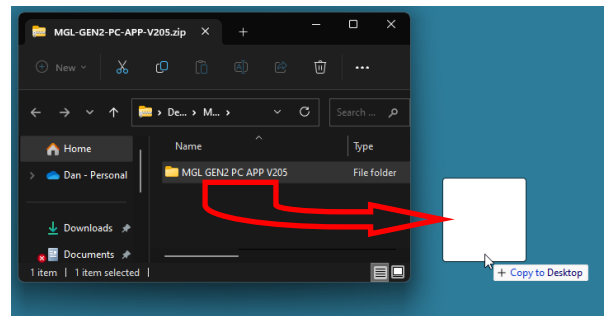

7. Double click on the folder you just dragged onto the desktop, then double click on the “setup” file:

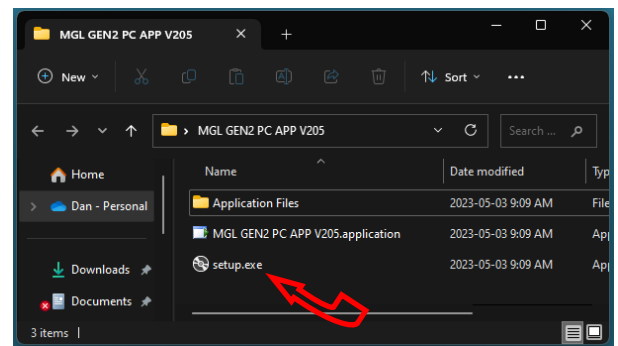

8. Click “More info”, “Run anyway”, “Install”, or similar on any warning windows which pop up, perhaps more than once.

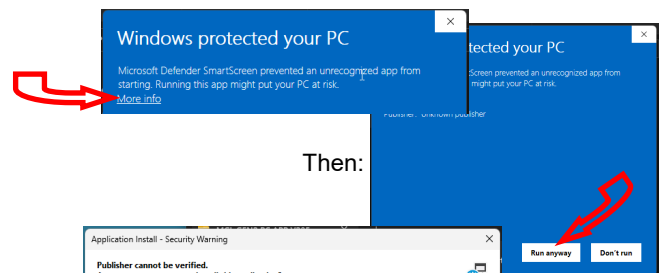

And:

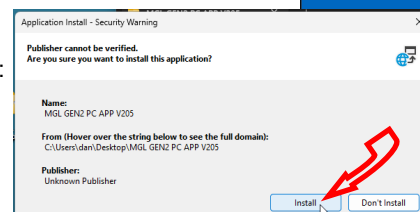

9. The PC App will open when it is finished installing. (In the future, it should be started from the start menu.) You are now ready to connect a USB cord between the laptop computer and GEN2 control board, and connect.

# Appendix D - PC App Installation (Windows 10 & earlier)

The PC App allows detailed interfacing with the control board using a Windows laptop computer. These instructions are for **Windows 10 or earlier**. First, install the USB driver as per the previous appendix.

The easiest way to install the PC App is from the **USB drive included with the unit**. Insert the USB stick into a Windows computer, and open a File Explorer window to view its contents:

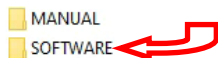

Double click on the **SOFTWARE** folder to show its contents:

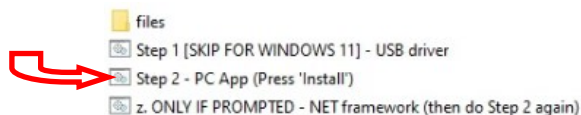

Double click on **Step 2** and follow the prompts, clicking “allow” or “yes” as required. If you get a warning that .NET framework is required, go back and double click on step z, then try **Step 2** again.

If the USB stick drive is not available, the same file can be **downloaded from the web page**.

1. Go to [www.nordicghp.com](http://www.nordicghp.com), Download Software page:

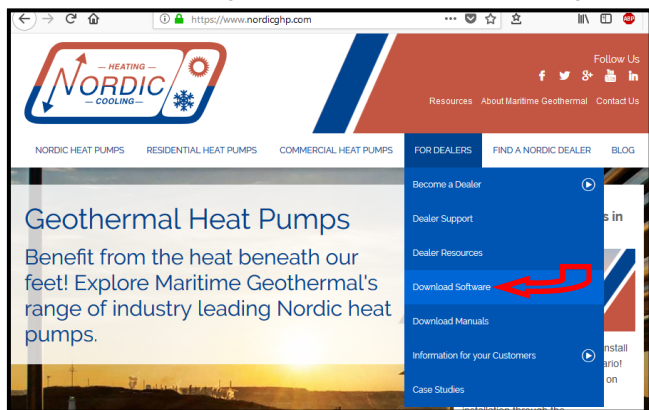

2. Click on **MGL GEN2 PC APP V2\_\_** to download it:

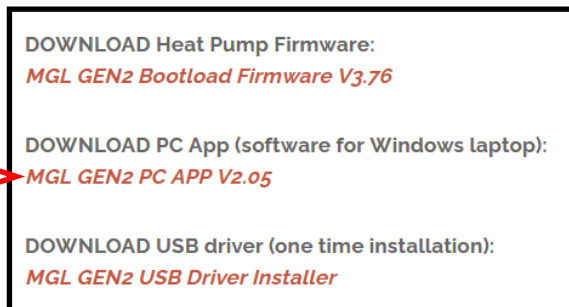

3. Choose “Open with Windows Explorer”, and hit “OK”:

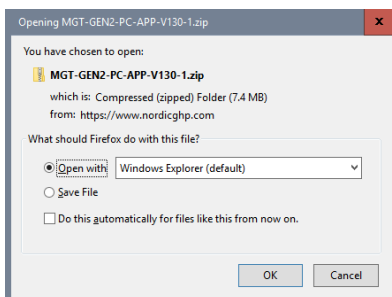

4. In the window that is displayed, click and hold down the mouse button on the folder name, and drag to your desktop:

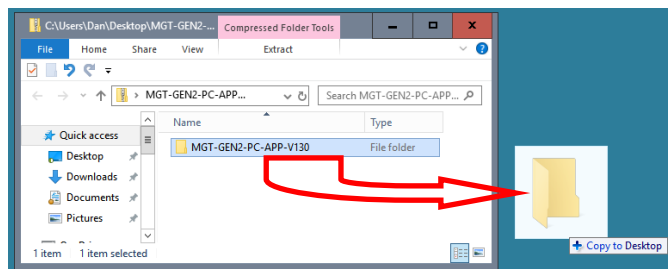

5. Double click on the folder you just dragged onto the desktop, then double click on the “setup” file:

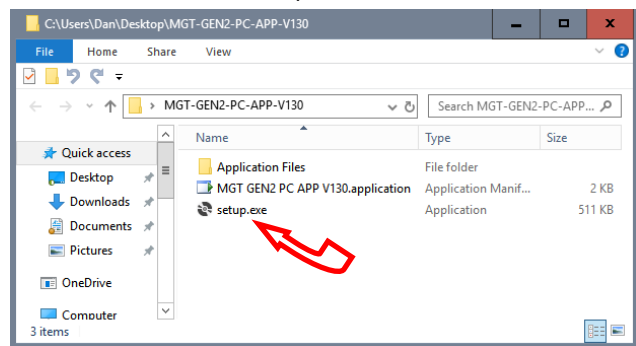

6. Click “Yes”, “Run”, “Install”, or similar on any warning windows which pop up. If an error message is encountered regarding .NET framework, exit the installation and use the link on the Download Software page to install the missing item:

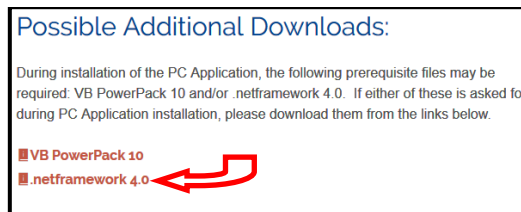

Then go back to step 5.

7. The PC App will open when it is finished installing. You are now ready to connect a USB cord between the laptop computer and GEN2 control board, and connect.



# Appendix E: Updating Firmware

## METHOD 1: Updating Firmware Using PC App

This method can be used when updating newer control boards with bootloader version 2.0. This method will not work for older control boards with bootloader version 1.0 (approx. unit serial numbers -17 and lower); for those, see **METHOD 2**. Note that **METHOD 2** will work for all control boards.

The firmware comes as a .ZIP file named: **MGL GEN2 Bootload Firmware Vxxx.zip** where xxx is the version reference, e.g. 376 (version 3.76). This file can be downloaded from [www.nordicgph.com](http://www.nordicgph.com), menu *For Dealers --> Download Software*.

1. Download the file to your PC. When prompted, "Open" the zip file. If the zip file is *Saved* instead of *Opened*, find it in the web browser's Downloads list or at the bottom of browser window and click on it to open. In the window that comes up, drag the folder containing the required files onto your desktop so that it can be found easily, e.g.:

**Desktop\MGL GEN2 Bootload Firmware V376**

Also be sure the latest PC App version (e.g. v2.05) is installed, which is listed alongside the firmware on the web page. If needed, install a new version as per those instructions, and uninstall older PC App versions to avoid their accidental use (which can corrupt control board parameters).

2. In that folder on the Desktop, there will be three files:
 

MGL_GEN2_V376.production.hex	(firmware file)
PIC32UBL.exe	(the programmer)
USB Bootloader Instructions.pdf	(these instructions)

Note that on most computers, the file extensions (.exe, .pdf) will be hidden.

3. Connect a USB (printer) cable between computer and control board.
4. Launch the PC App version that matches the firmware (e.g. PC App 2.05 for firmware V3.76). After it is installed, the PC App can be started using the entry found under the "M" section in the Windows **START** menu, which is accessed using the 4-rectangles icon normally found at the bottom left corner of the computer screen.

5. In the PC App, click on the **Connect** button to connect to the control board.

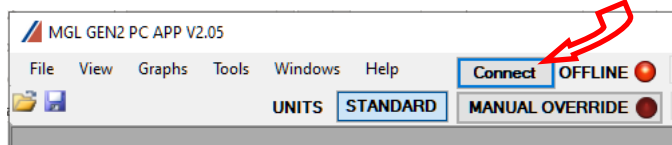

6. Go to menu **Tools --> Update Firmware**. The following message box will appear:

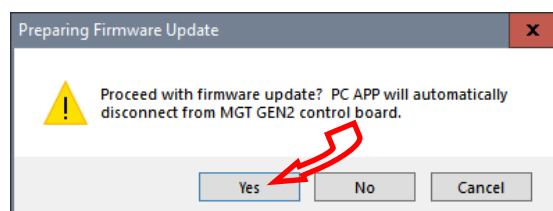

7. Click on **YES**. The following message box will appear:

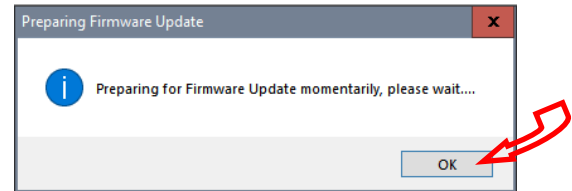

8. Click on **OK**. After a minute, the following message box will appear:

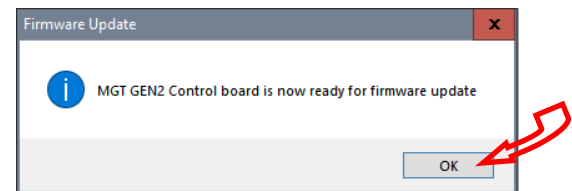

9. Click on **OK**. The control board is now in bootloader mode and is ready to be programmed.

10. Double click on the downloaded file PIC32UBL.exe to run it. In the window that opens, click on the USB **Enable** check box.

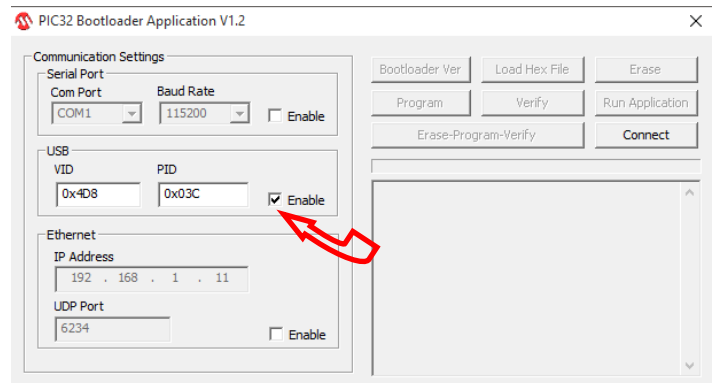

11. Click on **Connect**.

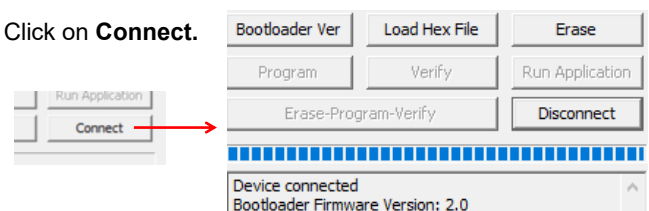

*If device fails to connect and an error message is displayed, the board's bootloader may be older than v2.0. It will be necessary to instead update the firmware via jumper pins (**METHOD 2**), as per the next section.*

- Click on **Load Hex File**. Select the *MGL\_GEN2\_V376.production.hex* (or higher version number) file, which is in the folder you created on the Desktop.

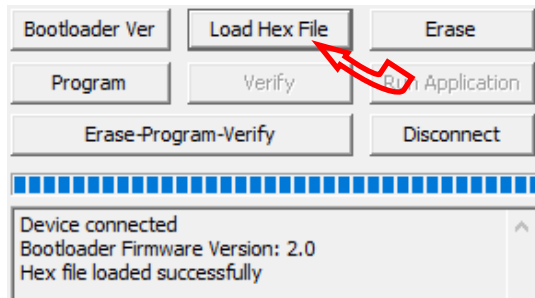

- Click on **Erase—Program—Verify**. Programming.... Wait while status bar shows progress. The messages should read as below when finished:

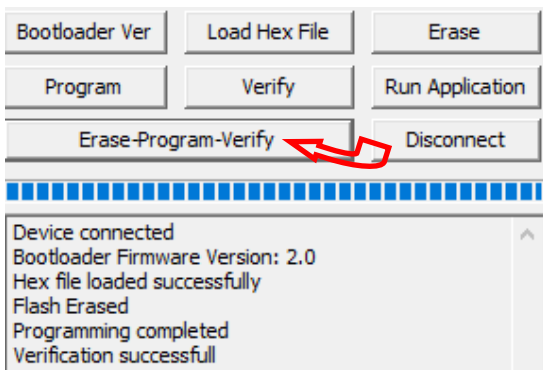

- “Programming completed. Verification successful.” Click on **Run Application**. This will take the control board out of bootloader mode and back into normal operational mode, so that the PC App can connect again.

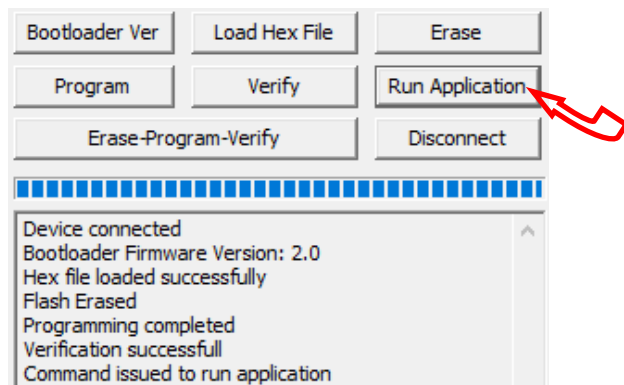

- Wait until the programmer disconnects itself. The messages should read as follows:

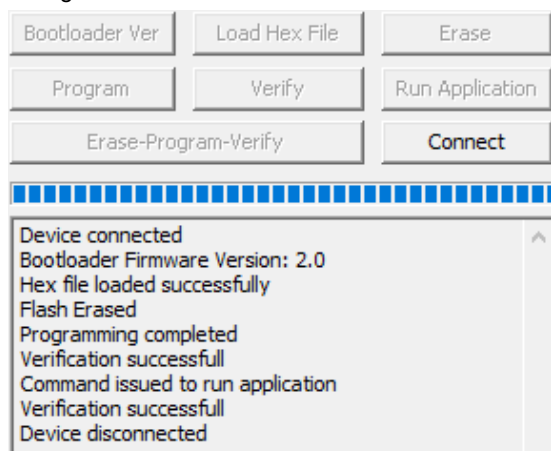

- Close the PIC32 program.
- WAIT APPROXIMATELY 10 SECONDS**. This gives the control board time to reset, initialize and re-connect to the PC USB port.
- Go back to the PC APP and click on the **Connect** button. Verify that the firmware version, shown in the title bar after connection, has been updated. Perform any configuration needed.

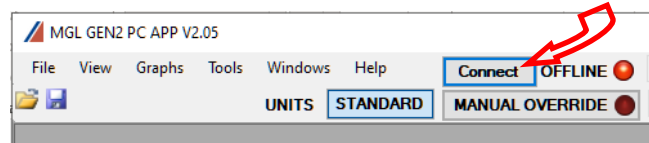

**NOTE: Updating the firmware does not affect the configuration settings.**

## Reset to Defaults?

When updating from **firmware V3.75 or earlier**, the following steps must be taken after the update as there are significant differences in the internal parameters used to operate the system. These steps may also be performed for troubleshooting, when the control system is not acting as it should.

Note that if the firmware on a heat pumps is 2.45 or earlier, chances are that it will have an older bootloader version that requires the use of **METHOD 2** to update the firmware (see following page).

- With PC App connected, go to menu **Tools --> Configuration** and note all settings. They will need to be re-set later.
- Go to menu **Tools --> Reset To Factory Defaults**. Click **YES** in the pop up window, and OK in the next window.

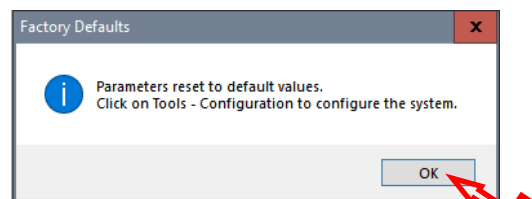
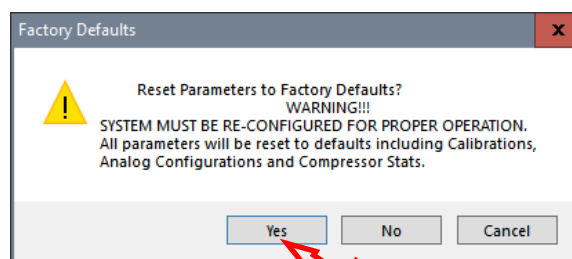

- Go back to menu **Tools --> Configuration**. Re-select the Model Series even if it already indicates the proper series, as clicking on it will load the parameters for that series.
- Select the Model Size and make any other changes that apply to the particular system setup such as number of stages, control method, etc.

## METHOD 2: Updating Firmware Using Jumper Pins

This method should be used when updating older control boards that have bootloader version 1.0, or where the PC App has trouble connecting to older firmware. This method will work for all control boards and can be used on all units.

The firmware comes as a .ZIP file named: **MGL GEN2 Bootload Firmware Vxxx.zip** where xxx is the version reference, e.g. 376 (version 3.76). This file can be downloaded from [www.nordicghp.com](http://www.nordicghp.com), menu *For Dealers* --> *Download Software*.

- Download the file to your PC. When prompted, "Open" the zip file. If the zip file is *Saved* instead of *Opened*, find it in the web browser's Downloads list or at the bottom of browser window and click on it to open. In the window that comes up, drag the folder containing the required files onto your desktop so that it can be found easily, e.g.:

**Desktop\MGL GEN2 Bootload Firmware V376**

- In that folder on the Desktop, there will be three files:
  - MGL\_GEN2\_V376.production.hex (firmware file)
  - PIC32UBL.exe (the programmer)
  - USB Bootloader Instructions.pdf (these instructions)

Note that on most computers, the file extensions (.exe, .pdf) will be hidden.

- Connect a USB (printer) cable between computer and control board.
- Turn power off to the heat pump.
- Remove one of the black pin jumpers from just below the USB connector on the board and place in on the center pin pair of the EXPANSION header as shown below.

*Borrow any one of these jumpers (however many are present)*

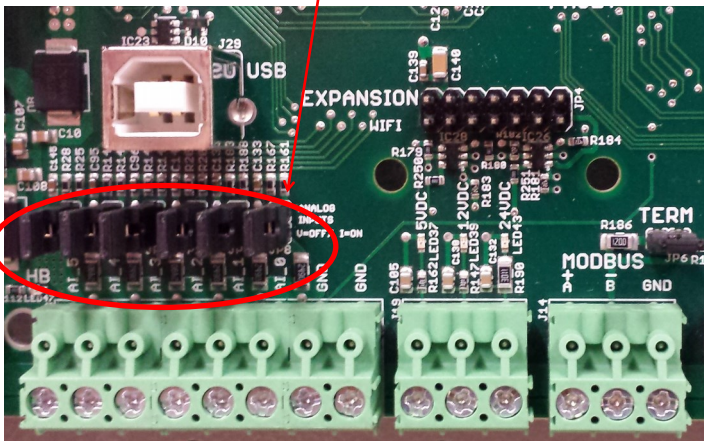

Place jumper here

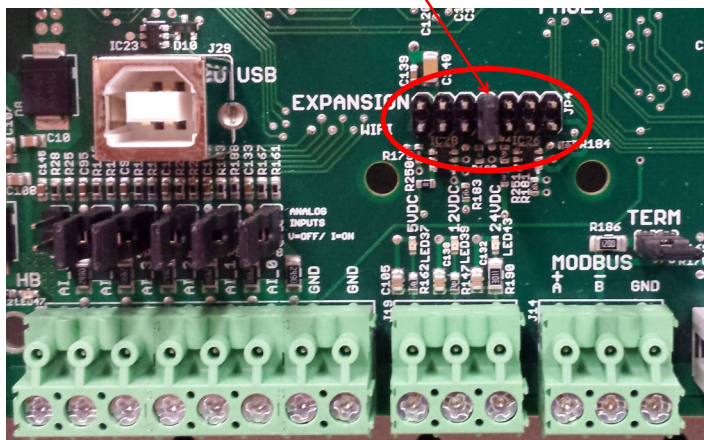

- Turn the power back on. The control board is now in boot loader mode and is ready to be programmed.
- Double click on the downloaded PIC32UBL.exe to run it. In the window that opens, click on the USB **Enable** check box.

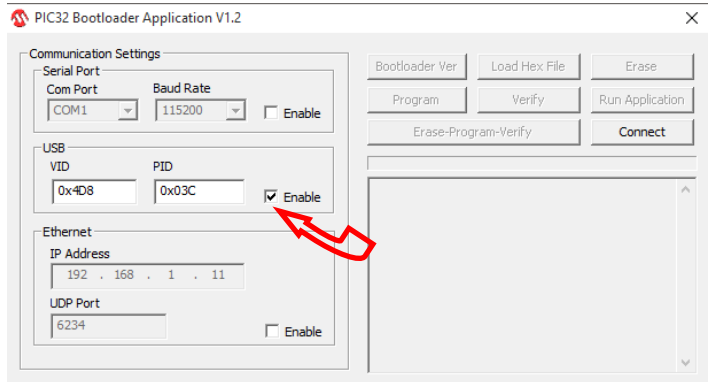

- Click on **Connect**.

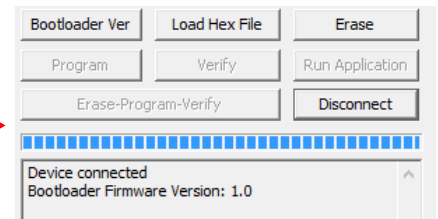
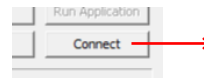

- Click on **Load Hex File**. Select the **MGL\_GEN2\_V376.production.hex** (or higher version number) file, which is in the folder you created on the Desktop.

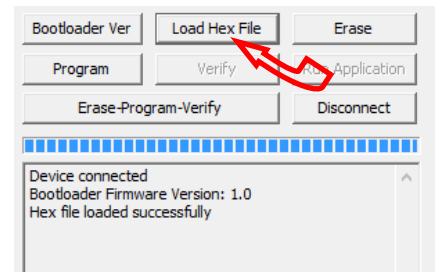

- Click on **Erase—Program—Verify**

Programming...

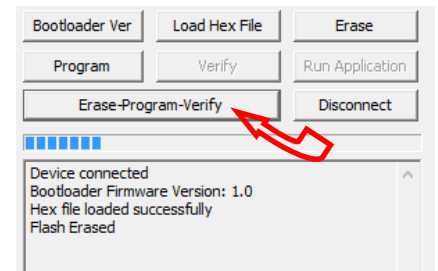

- "Programming completed. Verification successful." Click on **Disconnect** and close the program.

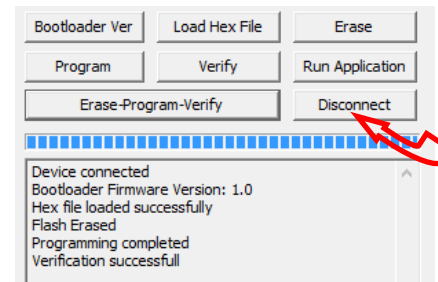

- Turn power off to the heat pump again.
- Move the jumper back to where it was taken from.
- Turn the power back on. Check that the LCD Display shows e.g. **MGL GEN2 V3.76** on the top line during power up.

## Warranty: PC Series

### COMMERCIAL LIMITED EXPRESS WARRANTY

Unless a statement is specifically identified as a warranty, statements made by Maritime Geothermal Ltd. ("MG") or its representatives relating to MG's products, whether oral, written or contained in any sales literature, catalogue or agreement, are not express warranties and do not form a part of the basis of the bargain, but are merely MG's opinion or commendation of MG's products.

**SET FORTH HERE IS THE ONLY EXPRESS WARRANTY THAT APPLIES TO MG'S PRODUCTS. MG MAKES NO WARRANTY AGAINST LATENT DEFECTS. MG MAKES NO WARRANTY OF MERCHANTABILITY OF THE GOODS OR OF THE FITNESS OF THE GOODS FOR ANY PARTICULAR PURPOSE.**

#### LIMITED EXPRESS COMMERCIAL WARRANTY - PARTS

MG warrants its Commercial Class products, purchased and retained in the United States of America and Canada, to be free from defects in material and workmanship under normal use and maintenance as follows:

- (1) Air conditioning, heating and/or unit units built or sold by MG ("MG Units") for one (1) year from the Warranty Inception Date (as defined below).
- (2) Thermostats, auxiliary electric heaters and geothermal pumping modules built or sold by MG, when installed with MG Units, for five (5) years from the Warranty Inception Date (as defined below).
- (3) Sealed refrigerant circuit components of MG Units (which components only include the compressor, refrigerant to air/water heat exchangers, reversing valve body and refrigerant metering device) for one (1) year from the Warranty Inception Date (as defined below).
- (4) Other accessories, when purchased separately, for (1) year from the date of shipment from MG.

**The "Warranty Inception Date" shall be the date of original unit installation, as per the date on the installation Startup Record; or sixty (60) days from date of unit shipment from MG, whichever comes first.**

To make a claim under this warranty, parts must be returned to MG in Petitcodiac, New Brunswick, freight prepaid, no later than ninety (90) days after the date of the failure of the part. If MG determines the part to be defective and within MG's Limited Express Commercial Warranty, MG shall, when such part has been either replaced or repaired, return such to a factory recognized distributor, dealer or service organization, freight prepaid. The warranty on any part repaired or replaced under warranty expires at the end of the original warranty period.

#### LIMITED EXPRESS COMMERCIAL WARRANTY - LABOUR

MARITIME GEOTHERMAL LTD. will not be responsible for any consequential damages or labour costs incurred.

This warranty does not cover and does not apply to:

- (1) Air filters, fuses, refrigerant, fluids, oil.
- (2) Products relocated after initial installation.
- (3) Any portion or component of any system that is not supplied by MG, regardless of the cause of the failure of such portion or component.
- (4) Products on which the unit identification tags or labels have been removed or defaced.
- (5) Products on which payment to MG, or to the owner's seller or installing contractor, is in default.
- (6) Products subjected to improper or inadequate installation, including but not limited to:
  - Indoor or outdoor loop flow lower than listed in engineering specification or as expressly approved by MARITIME GEOTHERMAL LTD.
  - Operating the unit either manually or with automated controls so that the unit is forced to function outside its normal operating range
  - Disabling of safety controls
  - Insufficient loop antifreeze concentration for loop temperature, or antifreeze concentration incorrectly set in control board
  - Fouled heat exchangers due to poor water quality
  - Failure to use strainers or clean them regularly
  - Impact or physical damage sustained by the unit
  - Poor refrigeration maintenance practices, including brazing without nitrogen flow, or using wrong braze/flux
  - Incorrect voltage or missing phase supplied to unit
  - Unit modified electrically or mechanically from factory supplied condition
  - Water quality outside of recommended limits (e.g. salinity or pH)
  - Unit not mounted with supplied anti-vibration grommets when specified for use
  - Corrosion damage due to corrosive ambient environment
  - Failure due to excessive cycling caused by improper mechanical setup or improperly programmed external controller
  - Physical loads or pressures placed on unit from external equipment
- (7) Mold, fungus or bacteria damage
- (8) Corrosion or abrasion of the product.
- (9) Products supplied by others.
- (10) Electricity or fuel, or any increases or unrealized savings in same, for any reason whatsoever.

MG is not responsible for:

- (1) The costs of fluids, refrigerant or system components **supplied by others**, or associated **labour** to repair or replace the same, which is incurred as a result of a defective part covered by MG's Limited Commercial Warranty.
- (2) The costs of **labour**, refrigerant, materials, or service incurred in diagnosis and removal of defective part, or in obtaining and replacing the new or repaired part.
- (3) Transportation costs of the defective part from the installation site to MG, or of the return of that part if warranty coverage declined.
- (4) The costs of normal maintenance.

MG'S LIABILITY UNDER THE TERMS OF THIS LIMITED WARRANTY SHALL APPLY ONLY TO THE MG UNITS REGISTERED WITH MG THAT BEAR THE MODEL AND SERIAL NUMBERS STATED ON THE INSTALLATION START UP RECORD, AND MG SHALL NOT, IN ANY EVENT, BE LIABLE UNDER THE TERMS OF THIS LIMITED WARRANTY UNLESS THIS INSTALLATION START UP RECORD HAS BEEN ENDORSED BY OWNER & DEALER/INSTALLER AND RECEIVED BY MG LIMITED WITHIN 90 DAYS OF START UP.

**Limitation:** This Limited Express Commercial Warranty is given in lieu of all other warranties. If, notwithstanding the disclaimers contained herein, it is determined that other warranties exist, any such express warranty, including without imitation any express warranties or any implied warranties of fitness for particular purpose and merchantability, shall be limited to the duration of the Limited Express Commercial Warranty.

#### LIMITATION OF REMEDIES

In the event of a breach of the Limited Express Commercial Warranty, MG will only be obligated at MG's option to repair the failed part or unit, or to furnish a new or rebuilt part or unit in exchange for the part or unit which has failed. If after written notice to MG's factory in Petitcodiac, New Brunswick of each defect, malfunction or other failure, and a reasonable number of attempts by MG to correct the defect, malfunction or other failure, and the remedy fails of its essential purpose, MG shall refund the purchase price paid to MG in exchange for the return of the sold good(s). Said refund shall be the maximum liability of MG. **THIS REMEDY IS THE SOLE AND EXCLUSIVE REMEDY OF THE BUYER OR PURCHASER AGAINST MG FOR BREACH OF CONTRACT, FOR THE BREACH OF ANY WARRANTY OR FOR MG'S NEGLIGENCE OR IN STRICT LIABILITY.**

#### LIMITATION OF LIABILITY

MG shall have no liability for any damages if MG's performance is delayed for any reason or is prevented to any extent by any event such as, but not limited to: any war, civil unrest, government restrictions or restraints, strikes, or work stoppages, fire, flood, accident, shortages of transportation, fuel, material, or labour, acts of God or any other reason beyond the sole control of MG. **MG EXPRESSLY DISCLAIMS AND EXCLUDES ANY LIABILITY FOR CONSEQUENTIAL OR INCIDENTAL DAMAGE IN CONTRACT, FOR BREACH OF ANY EXPRESS OR IMPLIED WARRANTY, OR IN TORT, WHETHER FOR MG'S NEGLIGENCE OR AS STRICT LIABILITY.**

#### OBTAINING WARRANTY PERFORMANCE

Normally, the dealer or service organization who installed the products will provide warranty performance for the owner. Should the installer be unavailable, contact any MG recognized distributor, dealer or service organization. If assistance is required in obtaining warranty performance, write or call Maritime Geothermal Ltd.

**NOTE:** Some states or Canadian provinces do not allow limitations on how long an implied warranty lasts, or the limitation or exclusions of consequential or incidental damages, so the foregoing exclusions and limitations may not apply to you. This warranty gives you specific legal rights, and you may also have other rights which vary from state to state and from Canadian province to Canadian province.